

# gumové profily

Mikroporézne profily v metráži	160	Profily tvaru „nota“, „e“, „L“	172
Mikroporézne profily samolepiace	162	Profily tvaru „T“	174
Profily z EPDM gummy – kompaktné	163	Profily tvaru „objímka“	175
Profily z NBR gummy – olejuodolné	165	Profily ostatné	176
Profily zo silikónovej expandovanej (mikroporéznej) gummy	166	Profily zo silikónovej gummy	179
Profily zo silikónovej kompaktnej gummy	167	Profily pireli – profily s kovovou výstuhou	180
Gumové profily „U“	168	Tesnenie okien automobilov	183



# gumové profily

## MIKROPORÉZNE PROFILY V METRÁŽI

### ↳ KRUHOVÝ PRIEREZ

- štandardná farba: čiernosivá
- materiál: EPDM (odolný poveternostným vplyvom)
- pracovná teplota: -30 °C/+80 °C

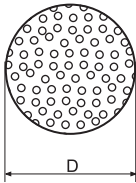

Mikroporézny profi l s dutinkou

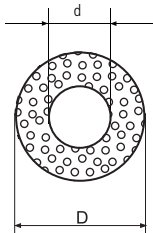

Iné rozmery na objednávku

### ↳ ŠTVORCOVÝ PRIEREZ

- štandardná farba: čiernosivá
- materiál: EPDM (odolný poveternostným vplyvom)
- pracovná teplota: -30 °C/+80 °C

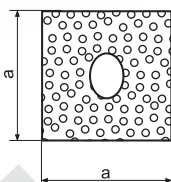
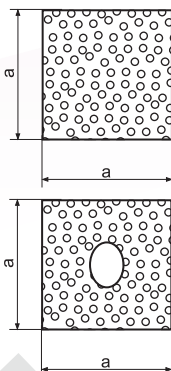

Využite možnosť nechať si v našich dielňach strojne urezať mikroporézne profily štvorcového prierezu v iných rozmeroch, z dosiek z mikroporéznej gumy T130 – 0463 xxx.

Obj. kód	Priemer D (mm)	Balenie (m-info)	Cena (€/m)
0532 003	3	200	0,207
0532 002	3,5	2000	0,207
0532 004	4	200	0,207
0532 005	5	200	0,207
0532 006	6	200	0,248
0532 007	7	200	0,331
0532 008	8	200	0,413
0532 009	9	200	0,455
0532 010	10	200	0,496
0532 012	12	200	0,661
0532 014	14	100	0,826
0532 015	15	100	0,909
0532 016	16	100	1,074
0532 017	17	100	1,281
0532 018	18	100	1,364
0532 020	20	50	1,694
0532 022	22	50	1,942
0532 024	24	50	2,355
0532 025	25	50	2,438
0532 026	26	50	2,645
0532 030	30	25	3,843
0532 040	40	25	6,322
0532 050	50	25	8,182

### KRUHOVÝ PRIEREZ S JEDNOU DUTINKOU

Obj. kód	Vonkajší priemer (mm)	Priemer dutinky (mm)	Balenie (m-info)	Cena (€/m)
0213 006	20	6	50	1,198
0213 008	20	8	50	1,116
0213 012	20	12	50	0,992
0213 015	30	15	25	1,860
0213 020	30	20	50	1,818
0213 022	30	22	50	2,355
0213 023	45	24	25	4,421

Obj. kód	Rozmer a×a (mm)	Počet dutiniek	Balenie (m-info)	Cena (€/m)
0530 005	5×5	–	500	0,248
0530 006	6×6	–	200	0,289
0530 008	8×8	–	200	0,455
0530 010	10×10	–	200	0,868
0530 110	10×10	–	100	0,785
0530 012	12×12	–	200	0,909
0530 015	15×15	–	100	1,116
0530 020	20×20	–	25	2,273
0530 025	25×25	–	50	2,934
0530 030	30×30	–	50	4,463
0530 040	40×40	–	25	7,686

### ŠTVORCOVÝ PRIEREZ S DUTINKOU

Obj. kód	Rozmer a×a (mm)	Počet dutiniek	Balenie (m-info)	Cena (€/m)
0530 112	12×12	1	100	0,868
0530 115	15×15	1	100	0,992
0530 220	20×20	1	50	2,066
0530 022	22×22	1	25	2,521
0530 225	25×25	1	50	2,934

Iné rozmery na objednávku.

## ↳ OBDĹŽNIKOVÝ PRIEREZ

- štandardná farba: čiernosivá
- materiál: **EPDM (odolný poveternostným vplyvom)**
- pracovná teplota:  $-30\text{ }^{\circ}\text{C}/+80\text{ }^{\circ}\text{C}$   
Iné rozmery na objednávku

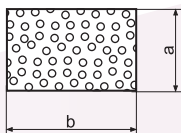

Obj. kód	Rozmer a x b (mm)	Balenie (m-info)	Cena (€/m)
0531 003	<b>3x7 obľý</b>	200	0,248
0531 005	<b>5x7 strieška</b>	100	1,116
0531 026	<b>2x6</b>	600	0,785
0531 036	<b>3,7x6</b>	600	0,165
0531 032	<b>3x20</b>	400	0,331
0531 033	<b>3x25</b>	200	0,455
0531 035	<b>3x36</b>	100	0,661
0531 034	<b>3x40</b>	100	0,661
0531 043	<b>4x30</b>	100	0,909
0531 050	<b>5x10</b>	200	0,372
0531 051	<b>5x15</b>	200	0,579
0531 052	<b>5x20</b>	200	0,661
0531 059	<b>5x25</b>	200	0,785
0531 053	<b>5x30</b>	100	0,950
0531 056	<b>5x33</b>	100	1,074
0531 054	<b>5x40</b>	100	1,074
0531 057	<b>5x43</b>	100	1,818
0531 055	<b>5x50</b>	100	1,364
0531 061	<b>6x10</b>	200	0,331
0531 062	<b>6x15</b>	200	0,579
0531 068	<b>6x8</b>	200	0,289
0531 072	<b>7x20</b>	50	1,116
0531 081	<b>8x10</b>	100	0,455
0531 083	<b>8x20</b>	100	1,240
0531 084	<b>8x30</b>	100	1,777
0531 101	<b>10x15</b>	100	0,785
0531 102	<b>10x20</b>	100	1,074
0531 099	<b>10x25</b>	50	1,405
0531 100	<b>10x25</b>	50	1,364
0531 103	<b>10x30</b>	100	1,570
0531 104	<b>10x40</b>	25	2,066
0531 106	<b>10x45</b>	100	2,314
0531 105	<b>10x50</b>	50	2,603
0531 107	<b>10x60</b>	50	3,017
0531 108	<b>10x80</b>	25	4,008
0531 152	<b>15x20</b>	50	1,570

Obj. kód	Rozmer a x b (mm)	Balenie (m-info)	Cena (€/m)
0531 155	<b>15x25</b>	50	1,942
0531 153	<b>15x30</b>	50	2,355
0531 201	<b>20x25</b>	50	2,934
0531 203	<b>20x30</b>	25	3,058
0531 235	<b>20x35</b>	25	4,421
0531 240	<b>20x40</b>	50	4,091
0531 253	<b>25x30</b>	25	3,802
0531 256	<b>25x60</b>	25	7,521
0531 300	<b>30x35</b>	25	5,000
0531 305	<b>30x50</b>	25	7,521
0531 355	<b>30x55</b>	25	8,595
0531 308	<b>30x80</b>	25	15,041

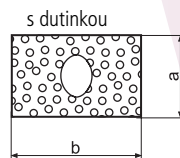

Obj. kód	Rozmer a x b (mm)	Počet dutiniek	Balenie (m-info)	Cena (€/m)
0531 111	<b>10x15</b>	1	100	0,785
0531 112	<b>10x20</b>	1	100	0,868
0531 113	<b>10x20</b>	3	100	1,240
0531 156	<b>15x20</b>	1	100	1,364
0531 202	<b>20x25</b>	2	25	2,727
0531 204	<b>20x30</b>	2	25	3,347
0531 306	<b>30x50</b>	2	25	9,050

↳ Ďalšie tvarové profily z mikroporéznej gummy, str. 168.  
Mikroporézne gummy v doskách, str. 148.  
Profily zo **silikonovej mikroporéznej gummy**  
pre teploty  $-60\text{ }^{\circ}\text{C}/+200\text{ }^{\circ}\text{C}$  str. 166.

- ↳ Mikroporézne profily v **presnejšom prevedení** (rozmerná tolerancia: podľa ISO 3302-1, trieda E3):
- Kruhový prierez (čierna farba, hustota  $450\text{ kg/m}^3$ , pracovná teplota  $-35\text{ }^{\circ}\text{C}/+110\text{ }^{\circ}\text{C}$ ) – 1461 xxx
  - Štvorcový prierez (čierna farba, hustota  $450\text{ kg/m}^3$ , pracovná teplota  $-35\text{ }^{\circ}\text{C}/+110\text{ }^{\circ}\text{C}$ ) – 1462 xxx
  - Obdĺžnikový prierez (čierna farba, hustota  $450\text{ kg/m}^3$ , pracovná teplota  $-35\text{ }^{\circ}\text{C}/+110\text{ }^{\circ}\text{C}$ ) – 1460 xxx



# gumové profily

## SAMOLEPIACE MIKROPORÉZNE PROFILY

- štandardná farba: čierna
  - základňa **so samolepiacou vrstvou**
  - materiál: **EPDM (odolný poveternostným vplyvom)**
  - samolepka je umiestnená na jednej, širšej strane profilu
  - pracovná teplota:  $-30\text{ }^{\circ}\text{C}/+80\text{ }^{\circ}\text{C}$
- Pri lepení profilov so samolepiacou vrstvou dodržujte predpísaný pracovný postup.

so samolepkou

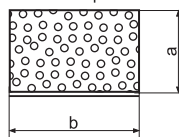

## ↳ SAMOLEPIACE MIKROPORÉZNE PROFILY OBDĹŽNIKOVÉHO PRIEREZU

Obj. kód	Rozmer (mm)	Balenie (m-info)	Cena (€/m)
0537 025	<b>2,5x8</b>	720	0,289
0537 033	<b>3x10</b>	720	0,455
0537 032	<b>3x15</b>	100	0,785
0537 031	<b>3x20</b>	720	0,785
0537 030	<b>3x36</b>	200	1,116
0537 034	<b>3x40</b>	100	0,992
0537 043	<b>4x30</b>	120	1,736
0537 049	<b>5x10</b>	20	3,967
0537 050	<b>5x20</b>	240	1,074
0537 054	<b>5x40</b>	120	1,736
0537 055	<b>5x50</b>	100	2,521
0537 061	<b>6x10</b>	240	0,826
0537 065	<b>6x15</b>	100	0,868

Obj. kód	Rozmer (mm)	Balenie (m-info)	Cena (€/m)
0537 081	<b>8x10</b>	240	0,909
0537 102	<b>10x20</b>	120	1,488
0537 103	<b>10x25</b>	100	1,860
0537 104	<b>10x40</b>	60	2,727
0537 105	<b>10x50</b>	15	3,843
0537 108	<b>10x80</b>	25	5,868
0537 110	<b>15x20</b>	25	2,769
0537 152	<b>15x25</b>	50	2,562
0537 153	<b>15x30</b>	25	3,058
0537 154	<b>20x30</b>	60	3,595
0537 156	<b>20x40</b>	25	4,876
0537 155	<b>20x50</b>	25	5,331
0537 253	<b>25x30</b>	25	4,380

## ↳ SAMOLEPIACE MIKROPORÉZNE PROFILY – ŠTVORCOVÉ

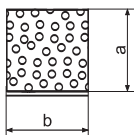

Obj. kód	Rozmer (mm)	Balenie (m-info)	Cena (€/m)
1457 080	<b>8x8</b>	200	0,785
1457 100	<b>10x10</b>	200	1,074

## ↳ SAMOLEPIACE MIKROPORÉZNE PROFILY – TVAROVÉ

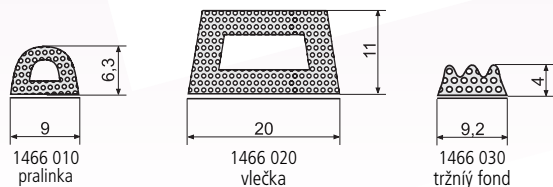

1466 010 pralinka

1466 020 vlečka

1466 030 tržný fond



1466 111 pralinka



1466 320 tržný fond

Obj. kód	Typ	Rozmer (mm)	Množstvo v balení (m)	Cena (€/ks)
1466 010	<b>pralinka/6 – prúd</b>	9x6,3	450 (3x150)	0,413
1466 020	<b>vlečka/2 – prúd</b>	20x11	120 (4x30)	0,950
1466 030	<b>tržný fond/6 – prúd</b>	9,2x4	720 (3x240)	0,331

### BALENIE VHODNÉ PRE MALOOBCHODNÝ PREDAJ

Obj. kód	Typ	Rozmer (mm)	Množstvo v balení (m)	Cena (€/ks)
1466 106	<b>pralinka/2 – prúd</b>	9x6,3	6	2,521
1466 111	<b>pralinka/4 – prúd</b>	9x6,3	11,2	4,628
1466 116	<b>pralinka/6 – prúd</b>	9x6,3	16,8	6,653
1466 310	<b>tržný fond/2 – prúd</b>	9,2x4	10	3,471
1466 320	<b>tržný fond/4 – prúd</b>	9,2x4	20	6,818
1466 330	<b>tržný fond/6 – prúd</b>	9,2x4	30	10,000

👁 Na zákazku možno dodať aj iné rozmery

## PROFILY Z EPDM GUMY – KOMPAKTNÉ (plný homogénny materiál)

- na objednávku aj iné rozmery a materiály
- niektoré rozmery len na objednávku

### ↳ PROFILY KRUHOVÉHO PRIEREZU – EPDM (ODOLNÉ VOČI POVETERNOSTNÝM VPLYVOM)

- štandardné parametre: čierna farba
- elastomér: EPDM (odolný voči poveternostným vplyvom a UV žiareniu)
- tvrdosť: 70 °Sh (alebo podľa tabulky)



Obj. kód	Priemer D (mm)	Tvrdosť (°ShA)	Balenie (m-info)	Cena (€/m)	Obj. kód	Priemer D (mm)	Tvrdosť (°ShA)	Balenie (m-info)	Cena (€/m)	
0594 020	2	70	200	0,165	0594 160	16	70	50	2,025	
0594 030	3		200	0,207	0594 180	18		50	2,521	
0594 035	3,5		200	0,289	0594 190	19		50	3,058	
0594 040	4		200	0,289	0594 200	20		50	3,223	
0594 050	5		200	0,413	0594 220	22		25	3,636	
0594 060	6		200	0,455	0594 240	24		25	4,091	
0594 070	7		200	0,620	0594 250	25		25	5,000	
0594 080	8		100	0,661	0594 280	28		25	5,661	
0594 090	9		100	1,901	0594 300	30		25	7,025	
0594 100	10		100	0,826	0594 320	32		25	7,479	
0594 111	11		100	0,909	0594 400	40		10	11,488	
0594 120	12		100	1,074	0594 081	8		60	100	0,661
0594 130	13		50	1,198	0594 101	10			100	0,826
0594 140	14		50	1,901	0594 121	12			100	1,074
0594 150	15		50	1,488						

### ↳ SPÁJANIE PROFILOV

Gumové profily na zákazku spájame vstrekováním alebo lepením (0990 029).

Upozornenie:

Tieto technológie sú vhodné pre väčšie výrobné série, pretože forma pre vstrekovanie je vyrábaná presne podľa požiadavky zákazníka. Podľa Vašich požiadaviek Vám pripravíme návrh konkrétneho riešenia pre Vašu aplikáciu.

Možno spájať: kompaktné profily a profily Pireli s kovovou výstuhou.

Ukážka spoja profilu:



0990 029



## ↳ PROFILY ŠTVORCOVÉHO PRIEREZU – EPDM (ODOLNÉ VOČI POVETERNOSTNÝM VPLYVOM)

- štandardné parametre: čierna farba
- elastomér: EPDM (odolný voči poveternostným vplyvom a UV žiareniu)
- tvrdosť: 70 °Sh

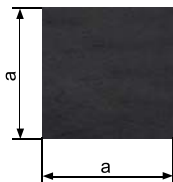

Obj. kód	Rozmer a x a (mm)	Tvrdosť (°ShA)	Balenie (m-info)	Cena (€/m)	
0595 060	6×6	70	100	0,744	
0595 080	8×8		100	1,033	
0595 100	10×10		100	1,529	
0595 120	12×12		100	1,570	
0595 130	13×13		100	1,694	
0595 140	14×14		50	2,975	
0595 150	15×15		100	2,066	
0595 160	16×16		50	2,190	
0595 180	18×18		50	3,017	
0595 200	20×20		50	3,719	
0595 300	30×30		25	9,504	
0595 131	13,5×13,5		60	50	2,810

## ↳ PROFILY OBDĹŽNIKOVÉHO PRIEREZU – EPDM (ODOLNÉ VOČI POVETERNOSTNÝM VPLYVOM)

- štandardné parametre: čierna farba
- elastomér: EPDM (odolný voči poveternostným vplyvom a UV žiareniu)
- tvrdosť: 70 °Sh

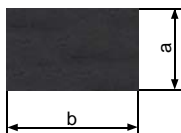

Obj. kód	Rozmer a x b (mm)	Tvrdosť (°ShA)	Balenie (m-info)	Cena (€/m)
0596 020	2×10	70	100	0,289
0596 032	3×13		100	1,777
0596 033	3×30		100	1,198
0596 036	3×36		100	1,364
0596 041	4×15		100	0,744
0596 046	4×60		50	2,479
0596 047	4×65		50	3,388
0596 050	5×10		100	0,992
0596 051	5×15		100	1,157
0596 052	5×20		100	1,570
0596 053	5×30		100	1,570
0596 054	5×40		100	1,901
0596 055	5×50		50	2,355
0596 062	6×20		100	1,405
0596 113	10×13	50	2,727	
0596 115	10×15	100	1,570	
0596 120	10×20	100	1,860	
0596 130	10×30	50	2,769	
0596 140	10×40	50	3,719	
0596 145	10×45	25	4,711	
0596 146	10×50	50	4,298	
0596 144	10×60	25	6,446	
0596 149	11×32	50	3,430	
0596 152	15×20	50	2,769	
0596 154	15×22	50	3,017	
0596 155	15×25	50	3,884	
0596 153	15×30	50	5,413	
0596 170	17×27	50	4,132	
0596 231	20×45	25	12,934	
0596 241	30×40	25	13,595	
0596 057	5×40	60	100	1,901
0596 056	5×50		100	2,355
0596 147	10×50		50	4,298
0596 230	20×30		50	9,050

↻ Na objednávku aj iné rozmery a v iných tvrdostiach.

Ďalšie tvarové profily z EPDM gummy, str. 169–170, 172–178.

↻ Základná odolnosť voči chemikáliám.

Tesniace gummy EPDM v kotúčoch, str. 150, 154.

↻ Využite možnosť strojného rezania gumenných pásov z gummy v kotúčoch podľa Vašich požiadaviek.



Lepidlá na lepenie gummy, str. 218.

Vhodnosť použitia lepidla konzultujte s našim predajným oddelením.

## PROFILY Z NBR GUMY – OLEJOVZDORNÉ

- na objednávku aj iné rozmery a materiály
- niektoré rozmery len na objednávku
- pre lepenie doporučujeme sekundové lepidlo CB 2004, CB 2008 – str. 219.

### ↳ PROFILY KRUHOVÉHO PRIEREZU – NBR (OLEJOVZDORNÉ)

- štandardné parametre: čierna farba
- elastomér: **NBR**, zmes 32–56 (olejuvzdorné)
- tvrdosť: **60 °Sh** (alebo podľa tabuľky)
- merná hmotnosť: 1,3 g/cm<sup>3</sup>
- použitie: napr. výroba neštandardných „O“ krúžkov



Obj. kód	Priemer D (mm)	Tvrdosť (°ShA)	Hmotnosť (kg/m)	Cena (€/kg)	Obj. kód	Priemer D (mm)	Tvrdosť (°ShA)	Hmotnosť (kg/m)	Cena (€/kg)
0538 003	3	60	0,009	21,198	0538 027	26	60	0,850	14,256
0538 002	3,5		0,011	20,992	0538 030	30		0,918	14,256
0538 004	4		0,016	16,860	0538 032	32		1,010	14,256
0538 001	4,5		0,020	16,860	0538 035	35		1,200	14,256
0538 005	5		0,026	16,860	0538 040	40		1,633	14,256
0538 006	6		0,037	16,860	0538 045	45		2,066	14,256
0538 007	7		0,050	16,860	0538 050	50		2,551	14,256
0538 008	8		0,065	16,446	0538 060	60		3,674	14,256
0538 010	10		0,102	14,256	0538 070	70		4,800	14,256
0538 009	10,5		0,102	14,256	0538 112	13		0,173	1,736
0538 011	11		0,123	14,256	0538 013	16		0,261	14,587
0538 012	12		0,147	14,256	0538 117	17		0,280	14,256
0538 213	13		0,160	14,256	0538 022	18		0,331	14,256
0538 014	14		0,153	14,256	0538 020	20		0,408	14,256
0538 015	15		0,230	14,256	0538 025	25		0,650	14,256
0538 016	16		0,261	14,256	0538 036	35		1,200	14,256
0538 018	18		0,331	16,405	0538 041	40		1,633	14,256
0538 019	19		0,360	14,256	0538 051	50		2,250	14,256
0538 024	20		0,460	14,256	0538 055	55		3,200	14,256
0538 023	23	0,539	14,256	0538 061	60	3,765	14,256		
0538026	25	0,650	14,256	0538 080	80	6,290	14,256		
				0538 910	110	11,880	16,405		

### ↳ PROFILY ŠTVORCOVÉHO PRIEREZU – NBR (OLEJOVZDORNÉ)

- štandardné parametre: čierna farba
- elastomér: **NBR**, zmes 32–56 (olejuvzdorné)
- tvrdosť: **60 °Sh** (alebo podľa tabuľky)
- merná hmotnosť: 1,3 g/cm<sup>3</sup>

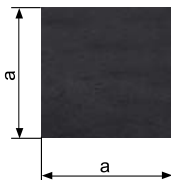

Obj. kód	Rozmer a x a (mm)	Tvrdosť (°ShA)	Hmotnosť (kg/m)	Cena (€/kg)
0539 003	3,7×3,7	60	0,018	16,860
0539 004	4×4		0,019	16,860
0539 006	6×6		0,043	16,860
0539 008	8×8		0,083	14,256
0539 010	10×10		0,135	14,256
0539 012	12×12		0,187	14,256
0539 015	15×15		0,293	14,256
0539 018	18×18		0,416	14,256
0539 020	20×20		0,520	14,256
0539 025	25×25		0,900	14,256
0539 040	40×40		1,920	14,256
0539 005	5×5		70	0,031
0539 026	25×25	45	0,840	14,256
0539 060	60×60	80	4,500	14,587



# gumové profily

PROFILY Z NBR GUMY – OLEJOVZDORNÉ  
/ PROFILY ZO SILIKÓNOVEJ EXPANDOVANEJ  
(MIKROPORÉZNEJ) GUMY

## ↳ PROFILY OBDĹŽNIKOVÉHO PRIEREZU – NBR (OLEJOVZDORNÉ)

- štandardné parametre: čierna farba
- elastomér: **NBR**, zmes 32–56 (**olejuvzdorné**)
- tvrdosť: 60 °Sh (alebo podľa tabuľky)
- merná hmotnosť: 1,3 g/cm<sup>3</sup>

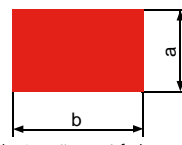
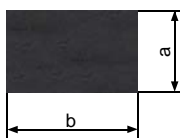

\*IR/NR, červená farba

Obj. kód	Rozmer a x b (mm)	Tvrdosť (°ShA)	Hmotnosť (kg/m)	Cena (€/kg)
0540 043	<b>4x32</b>	60	0,166	16,860
0540 042	<b>4x36</b>		0,187	14,256
0540 044	<b>4x45</b>		0,234	16,860
0540 058	<b>5x8</b>		0,052	16,860
0540 061	<b>6x14</b>		0,109	16,860
0540 072	<b>7x20</b>		0,182	14,256
0540 081	<b>8x10</b>		0,104	14,256
0540 082	<b>8,5x17</b>		0,188	14,256
0540 101	<b>10x15</b>		0,195	14,256
0540 102	<b>10x20</b>		0,26	14,256
0540 100	<b>10x23</b>		0,299	14,256
0540 103	<b>10x30</b>		0,390	14,256
0540 114	<b>12x25</b>		0,360	16,405

Obj. kód	Rozmer a x b (mm)	Tvrdosť (°ShA)	Hmotnosť (kg/m)	Cena (€/kg)	
0540 142	<b>14x24</b>	60	0,437	14,256	
0540 151	<b>15x18</b>		0,351	14,256	
0540 152	<b>15x20</b>		0,468	14,256	
0540 153	<b>15x25</b>		0,490	14,256	
0540 115	<b>15x30</b>		0,590	14,256	
0540 203	<b>20x30</b>		0,720	17,190	
0540 205	<b>20x50</b>		1,173	14,256	
0540 253	<b>25x30</b>		1,320	14,256	
0540 354	<b>35x45</b>		1,890	14,256	
<b>Profily IR/NR, červená farba, pre všeobecné použitie</b>					
0540 113*	<b>8x18</b>		70	0,210	14,256
0540 111*	<b>10x17</b>	0,240		14,256	
0540 112*	<b>10x20</b>	0,250		14,256	

↻ Na objednávku aj **iné rozmery a v iných tvrdostiach.**

➡ Ďalšie tvarové profily z NBR gummy, str. 171.

➡ Základná odolnosť voči chemikáliám.

Lepidlá na lepenie gummy, str. 219.

↻ Vhodnosť použitia lepidla konzultujte s našim predajným oddelením. Tesniace gummy z olejovzdornej gummy (NBR) v kotúčoch, str. 154.

↻ **Využite možnosť rezania gumenných pásov z gummy v kotúčoch podľa Vašich požiadaviek.**

## PROFILY ZO SILIKÓNOVEJ EXPANDOVANEJ (mikroporéznej) GUMY

### ↳ KRUHOVÝ PRIEREZ

- štandardná farba: biela
- elastomér: **silikón** VMQ, SIL 16 W
- hustota: 250 kg/m<sup>3</sup>
- pracovná teplota: **-60 °C/+200 °C**



### ↳ ŠTVORCOVÝ PRIEREZ

- štandardná farba: biela
- elastomér: **silikón** VMQ, SIL 16 W
- hustota: 250 kg/m<sup>3</sup>
- pracovná teplota: **-60 °C/+200 °C**
- ďalšie rozmery na zákazku

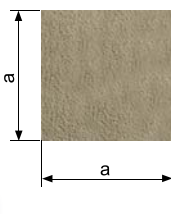

Obj. kód	Priemer D (mm)	Balenie (m-info)	Cena (€/m)
0506 010	<b>1</b>	25	0,496
0506 015	<b>1,5</b>		4,050
0506 020	<b>2</b>		0,537
0506 030	<b>3</b>		0,620
0506 040	<b>4</b>		0,785
0506 050	<b>5</b>		0,950
0506 060	<b>6</b>		1,281
0506 070	<b>7</b>		1,529
0506 080	<b>8</b>		1,777
0506 100	<b>10</b>		3,719
0506 107	<b>10,7</b>		3,595
0506 120	<b>12</b>		4,504
0506 150	<b>15</b>		9,298
0506 190	<b>19</b>		6,901
0506 254	<b>25,4</b>		7,273
0506 300	<b>30</b>		14,545

Obj. kód	Rozmer a x a (mm)	Balenie (m-info)	Cena (€/m)
0507 005	<b>5x5</b>	25	3,636
0507 008	<b>8x8</b>		4,628
0507 010	<b>10x10</b>		4,298
0507 012	<b>12x12</b>		7,273
0507 015	<b>15x15</b>		8,926
0507 020	<b>20x20</b>		12,479
0507 025	<b>25x25</b>		22,975

## ↳ OBDĽŽNIKOVÝ PRIEREZ

- štandardná farba: biela
- elastomér: **silikón** VMQ, SIL 16 W
- hustota: 250 kg/m<sup>3</sup>
- pracovná teplota: -60 °C/+200 °C
- ďalšie rozmery na zákazku

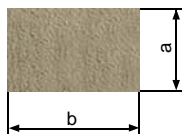

Obj. kód	Rozmer a x b (mm)	Balenie (m-info)	Cena (€/m)
0508 030	<b>3x10</b>		3,471
0508 033	<b>3x30</b>	25	6,529
0508 034	<b>3x30</b>	100	9,587
0508 035	<b>3x15</b>		2,851
0508 050	<b>5x10</b>		3,471
0508 052	<b>5x20</b>		6,116
0508 053	<b>5x30</b>		8,264
0508 055	<b>5x15</b>	25	5,289
0508 056	<b>5x25</b>		7,397
0508 081	<b>8x10</b>		5,496
0508 810*	<b>8x10</b>		10,331

Obj. kód	Rozmer a x b (mm)	Balenie (m-info)	Cena (€/m)
0508 082	<b>8,5x16,5</b>		6,376
0508 101	<b>10x15</b>		6,116
0508 102	<b>10x20</b>		6,901
0508 103	<b>10x30</b>		10,702
0508 104	<b>10x40</b>		14,959
0508 105	<b>10x50</b>		20,455
0508 106	<b>10x25</b>		8,058
0508 152	<b>15x20</b>	25	10,702
0508 153	<b>15x30</b>		16,446
0508 162	<b>15x25</b>		15,496
0508 203	<b>20x30</b>		22,769
0508 205	<b>20x50</b>		33,099
0508 212	<b>20x25</b>		17,025
0508 253	<b>25x30</b>		26,405
0508 304	<b>30x40</b>	10/25	39,256

↳ Ďalšie rozmery na objednávku.

↳ Ďalšie tvarové profily zo silikónovej mikroporéznej gumy dodávame na objednávku.

↳ Základná odolnosť chemikáliám.

Lepidlá na lepenie silikónu str. 219–220.

↳ Vhodnosť použitia lepidla konzultujte s našim predajným oddelením. Tesniace dosky zo silikónovej mikroporéznej gumy str. 151.

\* farba červená

## PROFÍLY ZO SILIKÓNOVEJ KOMPAKTNEJ GUMY

Silikónové kompaktné profily sa vyznačujú výbornými mechanickými vlastnosťami a sú zdravotne nezávadné.

Na objednávku dodávame aj v iných rozmeroch, tvrdostiach aj iných silikónových materiáloch.

## ↳ KRUHOVÝ PRIEREZ

- štandardná farba: biela
- elastomér: **silikón** VMQ, GP 60 W
- tvrdosť: **60 °Sh**
- hustota: 1190 kg/m<sup>3</sup>
- pracovná teplota: -60 °C/+230 °C



Obj. kód	Priemer D (mm)	Tvrdosť (°ShA)	Farba	Balenie (m-info)	Cena (€/m)
0501 010	<b>1</b>	60		25	0,496
0501 015	<b>1,5</b>	60		25	0,537
0501 020	<b>2</b>	60		25	0,579
0501 024	<b>2,4</b>	60		25	0,785
0501 030	<b>3</b>	60		25	0,702
0501 032	<b>3,2</b>	60	biela	25	10,826
0501 040	<b>4</b>	60		25	0,950
0501 041	<b>4</b>	50		50	1,033
0501 050	<b>5</b>	60		25	1,198
0501 051	<b>5</b>	40		25	2,479
0501 060	<b>6</b>	60		25	1,529

Obj. kód	Priemer D (mm)	Tvrdosť (°ShA)	Farba	Balenie (m-info)	Cena (€/m)
0501 062	<b>6</b>	50		50	1,942
0501 065	<b>6,5</b>	60		25	3,099
0501 070	<b>7</b>	60		25	2,025
0501 071	<b>7</b>	50		25	2,186
0501 080	<b>8</b>	60		25	2,479
0501 090	<b>9</b>	60		25	3,223
0501 100	<b>10</b>	60		25	3,719
0501 102	<b>12</b>	60	biela	25	3,967
0501 112	<b>11</b>	60		25	5,372
0501 127	<b>12,7</b>	60		25	5,785
0501 140	<b>14</b>	60		25	11,446
0501 160	<b>16</b>	60		25	10,702
0501 180	<b>18</b>	60		25	12,769
0501 200	<b>20</b>	60		25	15,083
0501 330	<b>30</b>	60		25	34,050
0501 043	<b>4,3</b>	60		25	1,570
0501 052	<b>5</b>	60		25	1,116
0501 061	<b>6</b>	60		25	1,529
0501 072	<b>7</b>	60	transparentná	25	2,025
0501 081	<b>8</b>	60		25	2,479
0501 111	<b>11</b>	50		25	5,818
0501 161	<b>16</b>	60		25	14,380
0501 441	<b>40</b>	60		5	76,074
0501 033	<b>3,2</b>	80	červená	25	7,273
0501 150	<b>15</b>	60		50	8,884



# gumové profily

PROFILY ZO SILIKÓNOVEJ KOMPAKTNEJ GUMY  
/ GUMOVÉ PROFILY TVARU „U“

## ŠTVORCOVÝ PRIEREZ

- štandardná farba: biela
- elastomér: **silikón** VMQ, GP 60 W
- tvrdosť: **60 °Sh**
- hustota: 1190 kg/m<sup>3</sup>
- pracovná teplota: **-60 °C/+230 °C**

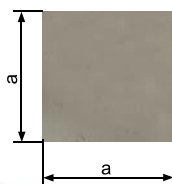

Obj. kód	Rozmer axa (mm)	Tvrdosť (°ShA)	Farba	Balenie (m-info)	Cena (€/m)
0502 005	<b>5×5</b>	60	biela	25	1,322
0502 006	<b>6×6</b>	60		25	1,942
0502 008	<b>8×8</b>	60		25	3,017
0502 010	<b>10×10</b>	60		10	5,579
0502 312	<b>12×12</b>	30		25	8,099
0502 412	<b>12×12</b>	45		25	19,091
0502 012	<b>12×12</b>	60		10	6,157
0502 015	<b>15×15</b>	60		25	9,545
0502 018	<b>18×18</b>	60		25	17,190
0502 020	<b>20×20</b>	60		25	21,281
0502 025	<b>25×25</b>	60	25	35,289	
0502 030	<b>30×30</b>	60	25	37,355	

## OBDĽŽNIKOVÝ PRIEREZ

- štandardná farba: biela
- elastomér: **silikón** VMQ, GP 60 W
- tvrdosť: **60 °Sh**
- hustota: 1190 kg/m<sup>3</sup>
- pracovná teplota: **-60 °C/+230 °C**

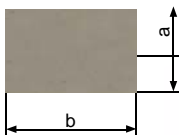

Obj. kód	Rozmer a×b (mm)	Tvrdosť (°ShA)	Farba	Balenie (m-info)	Cena (€/m)
0503 015	<b>1,5×20</b>	60	biela	25	6,694
0503 017	<b>3×6</b>	60		25	1,405
0503 028	<b>3×10</b>	60		25	2,314
0503 030	<b>3×20</b>	60		25	4,091
0503 031	<b>3,2×4,2</b>	60		25	3,967
0503 032	<b>3×25</b>	60		25	3,306
0503 033	<b>3×25</b>	45		25	5,868
0503 034	<b>3×25</b>	75		25	4,050
0503 037	<b>4×6</b>	55		25	2,190
0503 038	<b>4×8</b>	55		50	2,273
0503 040	<b>4×11</b>	60		25	5,041
0503 053	<b>5×35</b>	60		25	11,983
0503 060	<b>6×10</b>	60		25	4,463
0503 061	<b>6×8</b>	60		25	2,975
0503 065	<b>6×15</b>	60		25	4,752
0503 070	<b>7×9</b>	60		25	3,843
0503 075	<b>8×13</b>	60		25	7,686

Obj. kód	Rozmer a×b (mm)	Tvrdosť (°ShA)	Farba	Balenie (m-info)	Cena (€/m)	
0503 080	<b>8×20</b>	60	biela	25	7,975	
0503 081	<b>8,5×17</b>	60		25	8,802	
0503 083	<b>8×30</b>	60		25	16,736	
0503 084	<b>10×12</b>	60		25	8,140	
0503 085	<b>8×25</b>	60		25	11,446	
0503 086	<b>8×20</b>	33		25	8,388	
0503 087	<b>10×15</b>	40		25	7,769	
0503 112	<b>12×14</b>	60		25	15,702	
0503 115	<b>10×15</b>	60		25	9,711	
0503 120	<b>10×20</b>	60		25	8,471	
0503 130	<b>10×30</b>	60	25	18,388		
0503 144	<b>11×14</b>	60	25	12,190		
0503 150	<b>15×30</b>	60	25	25,661		
0503 152	<b>15×20</b>	60	25	15,950		
0503 153	<b>15×25</b>	60	25	17,934		
0503 019	<b>3×6</b>	60	červená	25	1,405	
0503 029	<b>3×10</b>	60		25	2,314	
0503 016	<b>3×6</b>	45	transparentná	25	2,438	
0503 018	<b>3,5×4</b>	60		25	3,967	
0503 039	<b>4×8</b>	55		50	2,273	
0503 048	<b>4×18</b>	55		50	4,256	
0503 056	<b>5×60</b>	60		25	33,719	
0503 082	<b>8×13</b>	60		25	12,314	
0503 036	<b>3×50</b>	40		čierna	25	8,926
0503 088	<b>10×16</b>	60		červenohnedá	25	8,306

### ➤ Ďalšie rozmery a farebné prevedenie na objednávku.

- RAL farby
- iné priemery
- iný silikónový materiál

### ➤ Ďalšie tvarové profily zo silikónovej kompaktnéj gumy dodávame na objednávku (min. 25 m) – str.179.

### 🛡️ Základná odolnosť voči chemikáliám.

Tesniace **dosky zo silikónovej gumy** str. 151.

**Lepidlá** na lepenie silikónu str. 219–220.

➤ Vhodnosť použitia lepidla konzultujte s našim predajným oddelením.

## GUMOVÉ PROFILY TVARU „U“

### MIKROPORÉZNE U PROFILY

- štandardná farba: čiernosivá
- materiál: **EPDM (odolné povernostným plyvom)**
- pracovná teplota: **-30 °C/+80 °C**

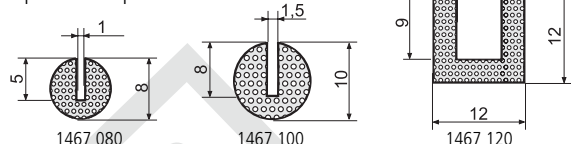

Obj. kód	Vonkajší rozmer (mm)	Šírka drážky (mm)	Balenie (m-info)	Cena (€/m)
1467 080	<b>8</b>	<b>1</b>	200	0,537
1467 100	<b>10</b>	<b>1,5</b>	100	0,496
1467 120	<b>12×12</b>	<b>6</b>	100	0,661

## PROFILY KRUHOVÉ S DRÁŽKOU

- štandardné vyhotovenie:
- elastomér: **EPDM (odolné poveternostným vplyvom)**, alebo podľa tabuľky, farba čierna
- tvrdosť: **70 °Sh**
- výroba profilov na zákazku z vami dodaných podkladov (výkresov, odtlačkov, vzoriek)

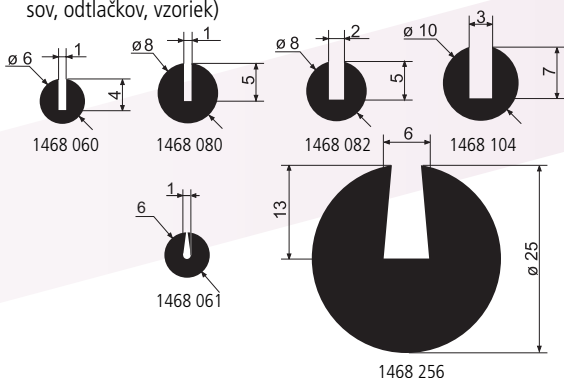

Obj. kód	Vonkajší priemer (mm)	Šírka drážky (mm)	Elastomér	Tvrdosť (°ShA)	Balenie (m-info)	Cena (€/m)
1468 060	6	1	EPDM	70	100	0,455
1468 080	8	1	EPDM	70	100	1,116
1468 082	8	2	EPDM	70	100	0,579
1468 104	10	3	EPDM	70	100	0,744

Obj. kód	Vonkajší priemer (mm)	Šírka drážky (mm)	Elastomér	Tvrdosť (°ShA)	Hmotnosť (kg/m)	Cena (€/kg)
1468 061	6	1	SBR/IR	60	0,05	6,322
1468 081	8	2	SBR/IR	60	0,07	7,025
1468 103	10	3	SBR/IR	60	0,09	5,744
1468 256	25	6	NBR – oleju-odolné	60	0,50	14,256
1468 311	30	11	EPDM	70	0,63	16,405

Profily kruhového prierezu v tvare hadice z rôznych materiálov – 0542 xxx.

## „U“ PROFILY – KOMPAKTNÁ GUMA EPDM (odolné poveternostným vplyvom)

- materiál z kompaktnej gumy: **EPDM (odolná poveternostným vplyvom)**, farba čierna

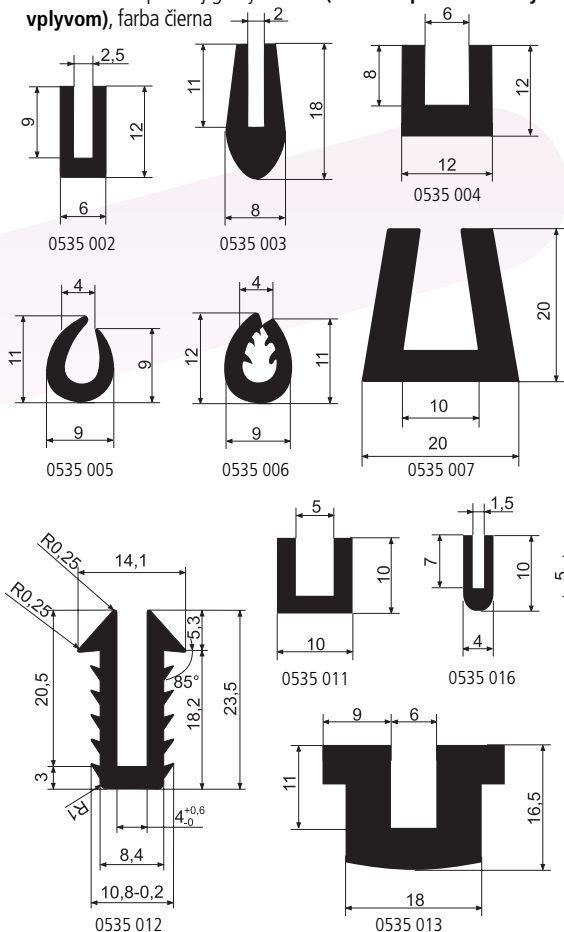

Obj. kód	Rozmer (mm)	Tvrdosť (°ShA)	Balenie (m-info)	Cena (€/m)
0535 002	6×9/2,5	60	100	0,826
0535 003	8×20/2	60	200	0,992
0535 004	12×12/6	60	100	1,116
0535 005	8×11/4	70	100	0,702
0535 006	9×12/4	60	100	0,744
0535 007	20×20/10	70	50	2,603
0535 011	10×10/5	60	100	1,446
0535 012	10,8×23,5/8,4	60	100	1,653
0535 013	12×18/6	70	50	3,388
0535 015	15×15/10	70	50	1,488
0535 016	10×4/1,5	70	100	1,116
0535 018	12×14/8	60	50	1,240
0535 022	20			



# gumové profily

GUMOVÉ PROFILY „U“

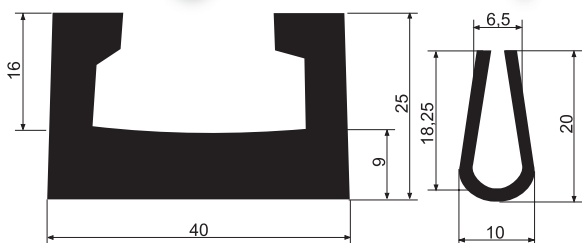

0535 027

0535 028

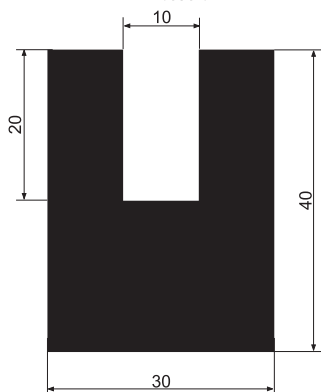

0535 030

0535 031

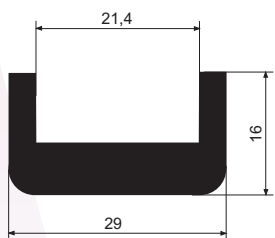

0535 032

0535 033

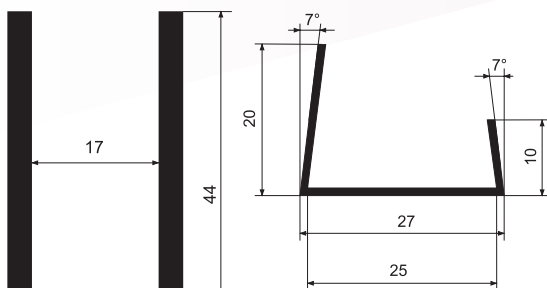

0535 035

0535 038

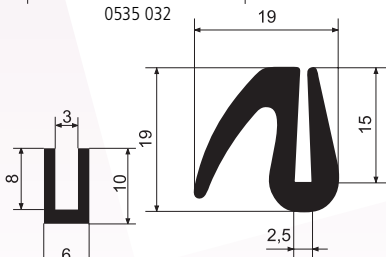

0535 049

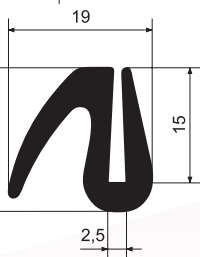

0535 060

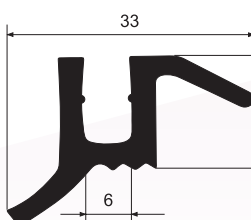

0535 065

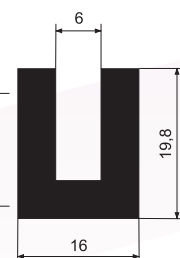

0535 067

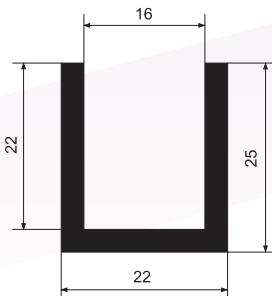

0535 068

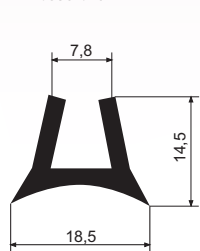

0535 072

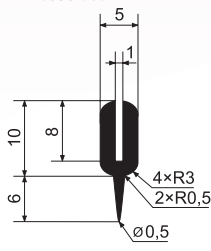

0535 078

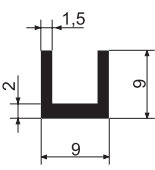

0535 090

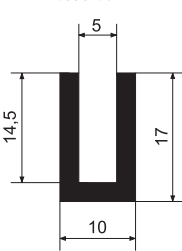

0535 095

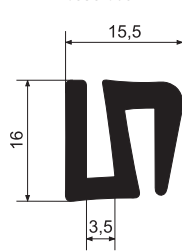

0535 136

Obj. kód	Rozmer (mm)	Tvrdosť (°ShA)	Balenie (m-info)	Cena (€/m)
0535 027	25×40/9	80	25	11,777
0535 028	20×10/6,5	70	100	1,901
0535 030	30×40/10	60	25	11,612
0535 031	24×16/6	70	50	2,727
0535 032	16×29/21,4	70	25	3,967
0535 033	12×14/4	70	100	1,983
0535 035	23×44/17	60	50	2,893
0535 038	20×27/25	70	50	1,446
0535 049	6×10/3	70	100	1,488
0535 060	19×19/2,5	60	50	2,190
0535 065	14,5×33/6	70	50	3,182
0535 067	16×19,8/6	70	50	2,645
0535 068	22×25/16	70	50	2,273
0535 072	18,5×14,5/7,8	70	50	2,314
0535 078	5×16/1	70	50	1,074
0535 090	9×9/5,5	70	100	0,950
0535 095	9×15/5	60	100	5,579
0535 136	15×16,3/2,8	70	50	2,562

➤ Ďalšie tvarové profily z kompaktnej EPDM gumi na objednávku.  
 Ďalšie profily z kompaktnej EPDM gumi (kruhov ,  tvorcov  a obdĺnikov  prierezy) str. 163.  
 Tesniaca guma EPDM v kot och str. 150, 154.

## „U“ PROFILY – KOMPAKTNÁ GUMA (OLEJOVZDORNÉ A INÉ)

- štandardný materiál: NBR – odolný olejom, SBR/NR pre všeobecné použitie
- štandardná farba: čierna so stopami po sivom mastenci
- elastomér a tvrdosť podľa špecifikácie v tabuľke

Obj. kód	Rozmer (mm)	Elastomér	Tvrdosť (°ShA)	Hmotnosť (kg/m)	Cena (€/kg)
0535 017	12×7/2	NBR – olej-uodolné	60	0,070	14,256
0535 021	22×8/3	NBR – olej-uodolné	60	0,123	14,256
0535 024	35×25/9	SBR/NR	60	0,940	14,174
0535 029	8×12/4	SBR/NR	60	0,090	14,256
0535 050	8×12/4	SBR/NR	60	0,090	14,256
0535 051	4×7,5/0,8	NBR – olej-uodolné	60	0,035	14,256
0535 052	8×14/2	SBR/NR	60	0,100	14,256
0535 053	22×32×22/4×9	SBR/NR	60	0,600	14,256
0535 054	23×34/4	SBR – všeobecné	60	1,030	14,256
0535 055	36×20	SBR – všeobecné	60	0,040	14,256
0535 056	30×23/8	NBR – olej-uodolné	60	0,470	14,256
0535 057	18×12/3	SBR/NR	60	0,210	14,256
0535 058	10×18/5	NBR – olej-uodolné	60	0,100	14,256
0535 059	32×12/4	NBR – olej-uodolné	60	0,362	14,256
0535 061*	18×12/3	IR/NR	70	0,380	14,256
0535 062*	37×28/10	IR/NR	60	0,470	15,083
0535 063	30×23/8	NBR – olej-uodolné	60	0,500	14,256

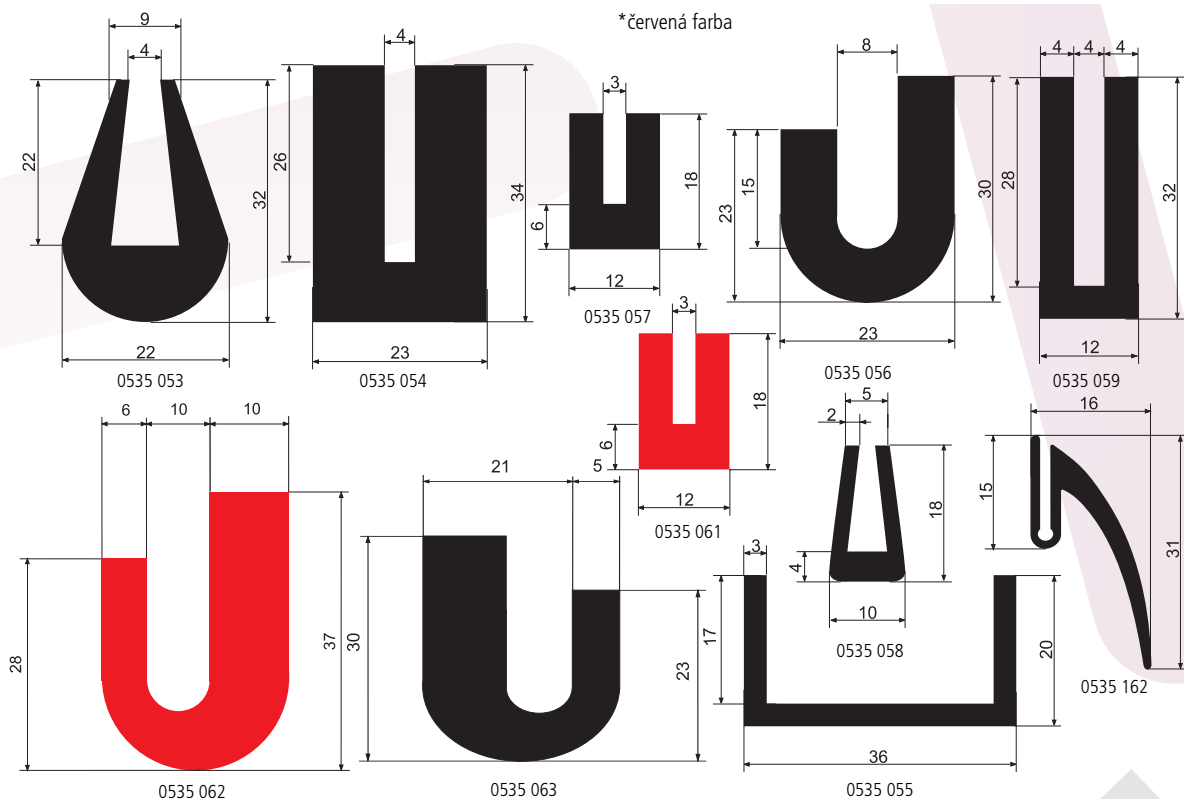
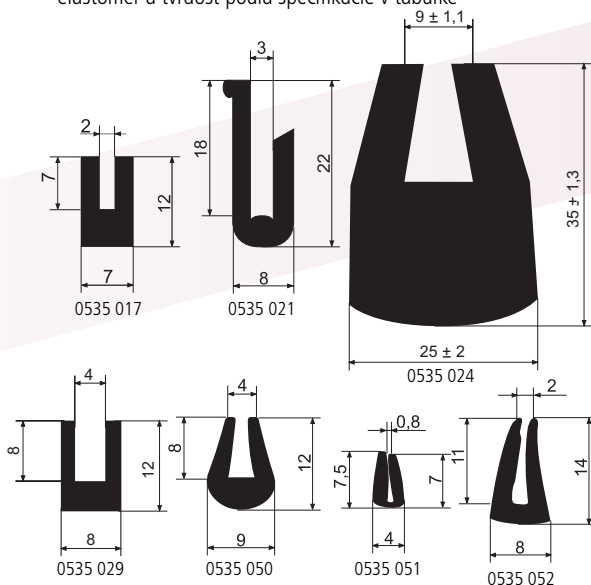

\*červená farba

Ďalšie tvarové profily z kompaktnej NBR gummy a ďalších zmesí na objednávku.  
Ďalšie profily z kompaktnej NBR gummy (kruhovú, štvorcovú a obdĺžnikovú prierezy) str. 165.  
Tesniaca guma NBR v kotúčoch str. 150, 154.



# gumové profily

## PROFILY TVARU „NOTA“, „e“, „L“

- štandardný materiál: elastomer podľa špecifikácie v tabuľke, farba čierna
- tvrdosť podľa uvedenia v tabuľke
- NBR – olejovzdorná, SBR/NR – pre všeobecné použitie, EPDM – odolná poveternostným vplyvom

Obj. kód	Rozmer (mm)	Typ	Elastomér	Tvrdosť (°ShA)	Hmotnosť (kg/m)	Balenie (Mj – info)	Mj.	Cena (€/Mj.)
0536 001	12×13/2	e	SBR – všeobecné	60	0,080	1 kg	14,256	
0536 039	21×22×2,5		EPDM	60	0,230	50 m	13,512	
0536 080	20×20/2,5		EPDM	70	0,200	50 m	2,893	
0536 252	20×18×2		EPDM	60	0,180	50 m	2,851	
0536 003	20×20×dĺžka 2500 mm	L	NBR – olejovzdorné	60	0,140	1 kg	14,256	
0536 215	20×20/4		EPDM	70	0,160	50 m	1,446	
0536 004	19×46×dĺžka 2500 mm	NOTA	SBR/NR	60	0,410	1 ks	15,455	
0536 013	10×36×dĺžka 2500 mm		SBR/NR	60	0,240	1 kg	14,256	
0536 014	10×30		EPDM – mikro	0	0,090	50 m	1,364	
0536 018	10×30		EPDM – mikro	0	0,085	100 m	1,074	
0536 035	10×35		EPDM – mikro	0	0,090	100 m	1,777	
0536 040	40×50×dĺžka 5100 mm		NBR – olejovzdorné	60	0,729	1 kg	16,322	
0536 041	8×59		EPDM	70	0,170	100 m	1,570	
0536 044	19×46×dĺžka 4400 mm		EPDM	60	0,360	1 ks	27,190	
0536 046	19×46×dĺžka 4400 mm		NBR – olejovzdorné	60	0,360	1 ks	27,190	

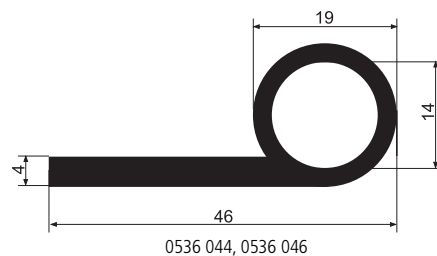
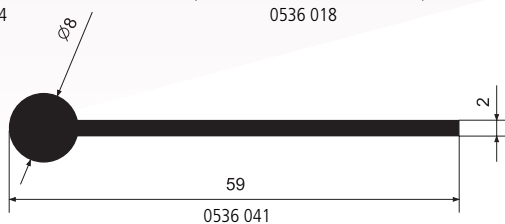
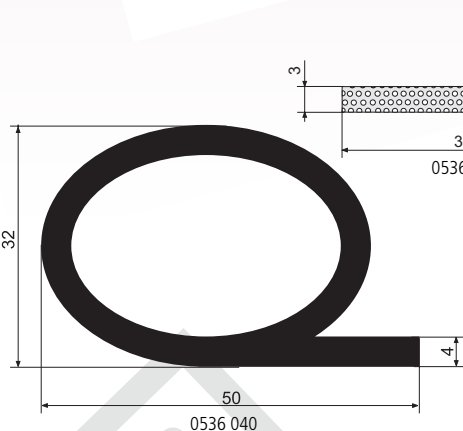
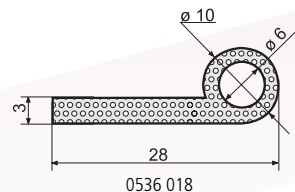
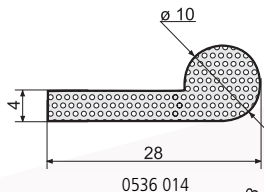
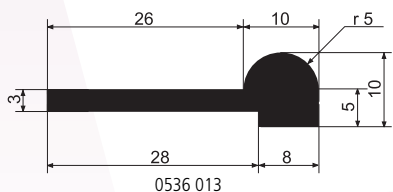
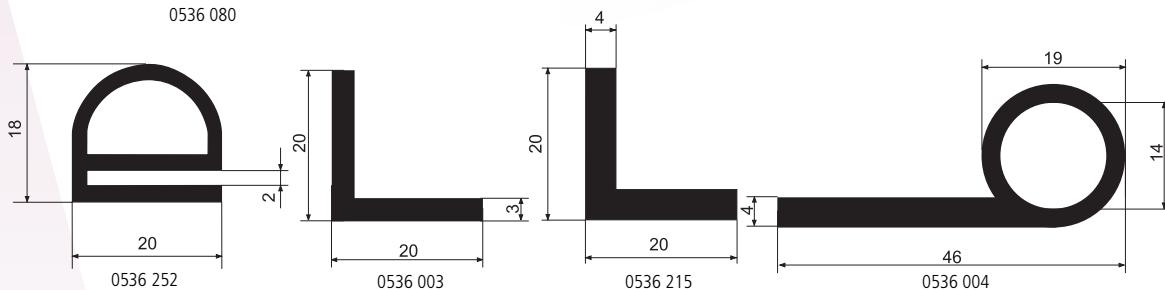
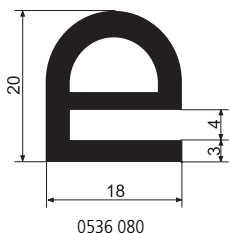
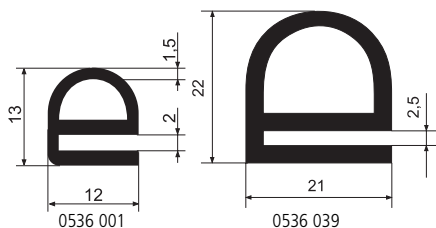

# gumové profily

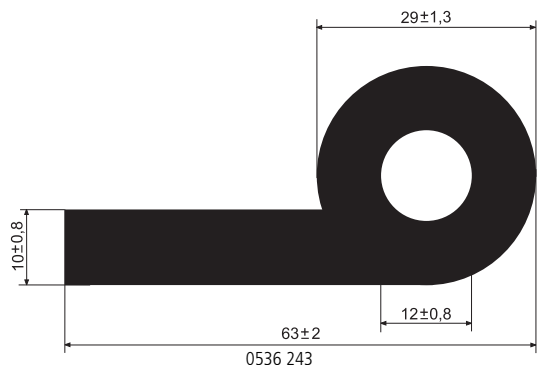
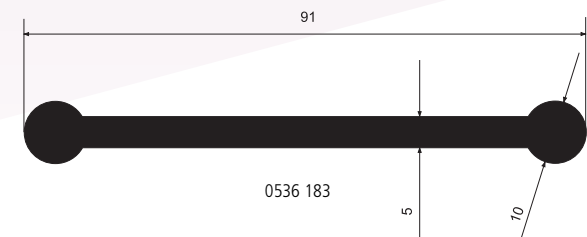
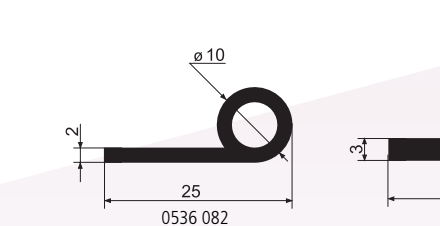
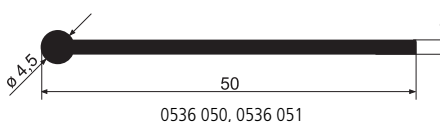
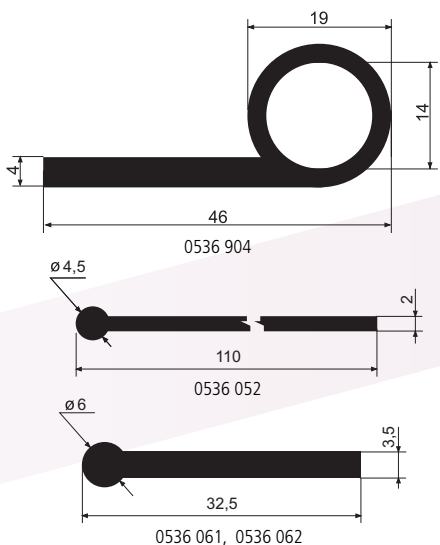

Obj. kód	Rozmer (mm)	Typ	Elastomér	Tvrdosť (°ShA)	Hmotnosť (kg/m)	Balenie (Mj.-info)	Mj.	Cena (€/Mj.)
0536 904	<b>19×46×délka 4400 mm</b>		SBR – všeobecné	60	0,360	1	ks	27,190
0536 050	<b>4,5×50</b>		EPDM	70	0,285	100	m	1,570
0536 051	<b>4,5×50</b>		EPDM	50	0,285	100	m	1,488
0536 052	<b>4,5×110</b>		EPDM	50	0,285	50	m	2,769
0536 053	<b>4,5×50</b>		EPDM	50	0,160	100	m	1,736
0536 054	<b>27×14/2,5</b>		EPDM	70	0,140	50	m	4,504
0536 061	<b>6×32</b>	NOTA	EPDM	60	0,130	100	m	1,736
0536 062	<b>6×32</b>		EPDM	70	0,130	100	m	1,694
0536 082	<b>25×10/2</b>		EPDM	70	0,110	100	m	1,488
0536 115	<b>20×42/3</b>		EPDM	60	0,300	50	m	2,769
0536 164	<b>6×42/30</b>		EPDM	60	0,175	50	m	1,860
0536 183	<b>91×81/10×délka 1750 mm</b>		EPDM	60	0,671	1	ks	19,669
0536 187	<b>36×7/3</b>		EPDM	70	0,150	50	m	1,942
0536 243	<b>29×65/10</b>		EPDM	60	1,150	25	m	19,587
0536 273	<b>28×11/2</b>	EPDM	70	0,131	50	m	1,983	
0536 056	<b>70×29</b>	EPDM	70	1,120	25	m	17,190	

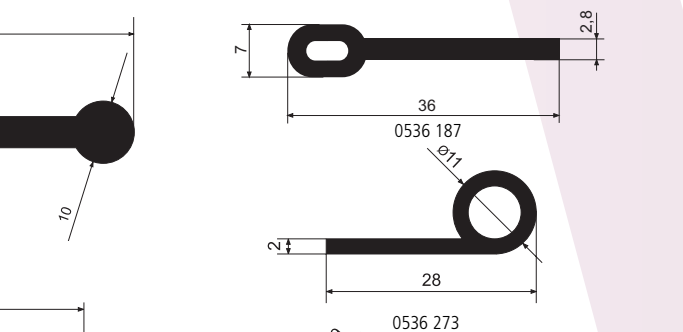
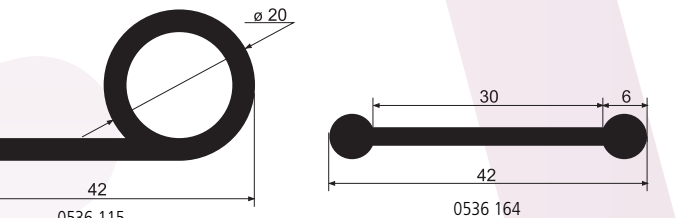
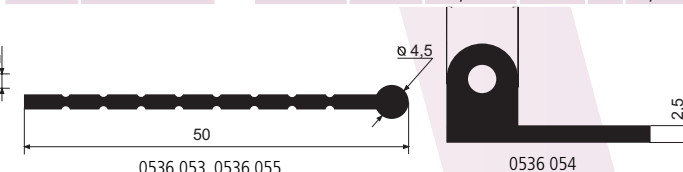



# gumové profily

## PROFILY TVARU „T“

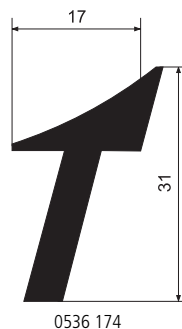
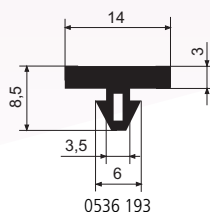
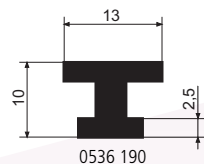
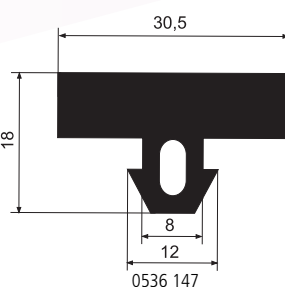
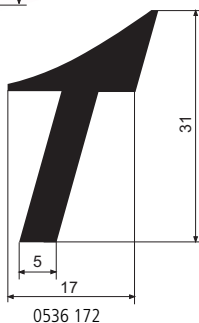
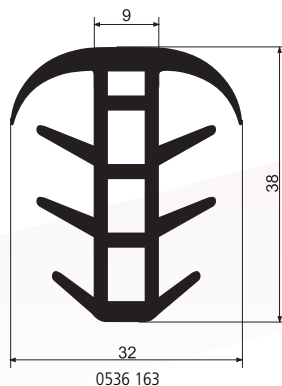
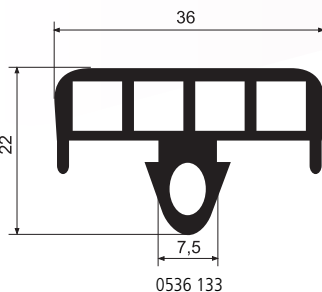
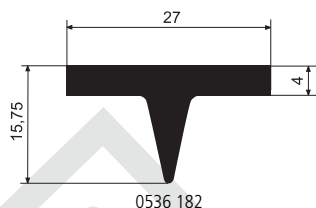
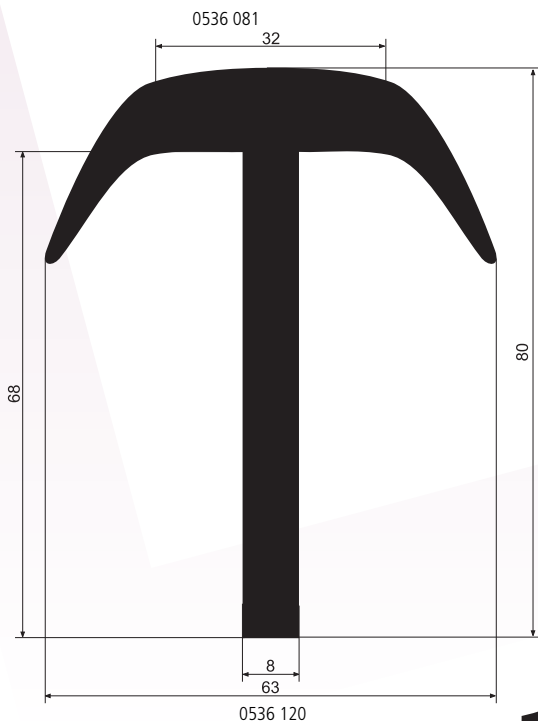
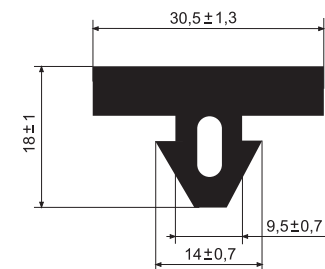
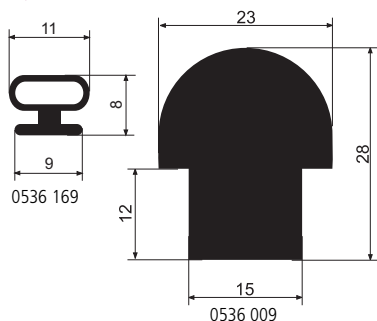

Obj. kód	Rozmer (mm)	Elastomér	Tvrdosť (°ShA)	Hmotnosť (kg/m)	Balenie (Mj.-info)	Mj.	Cena (€/Mj.)
0536 169	8×11/2	EPDM	70	0,090	100	m	1,694
0536 009	23×28	SBR – všeobecné	60	0,570	1	kg	14,256
0536 081	18×30,5/9,5	EPDM	70	0,400	50	m	2,851
0536 120	65×80/8×dĺžka 3150 mm	EPDM	70	1,273	1	ks	34,174
0536 133	36×22/7,5	EPDM	70	0,440	25	m	2,727
0536 147	18×30,5/8	EPDM	70	0,453	50	m	2,727
0536 163	32×38/9	EPDM	70	0,450	50	m	2,479
0536 170	10,5×13,5/1	EPDM	70	0,100	100	m	1,570
0536 172	17×31/5	EPDM	70	0,276	25	m	3,099
0536 174	21×7/3	EPDM	70	0,067	50	m	1,736
0536 175	50×70/11×dĺžka 3200 mm	EPDM	70	1,628	1	ks	74,091
0536 182	27×15/2	EPDM	70	0,200	30	m	3,347
0536 190	10×13/2	NBR – olejoodolné	60	0,120	1	kg	14,256
0536 193	14×8,5/6	EPDM	60	0,073	50	m	1,942
0536 212	36×25/13	EPDM	70	0,460	25	m	3,884
0536 226	12×20/3	EPDM	70	0,204	100	m	2,025

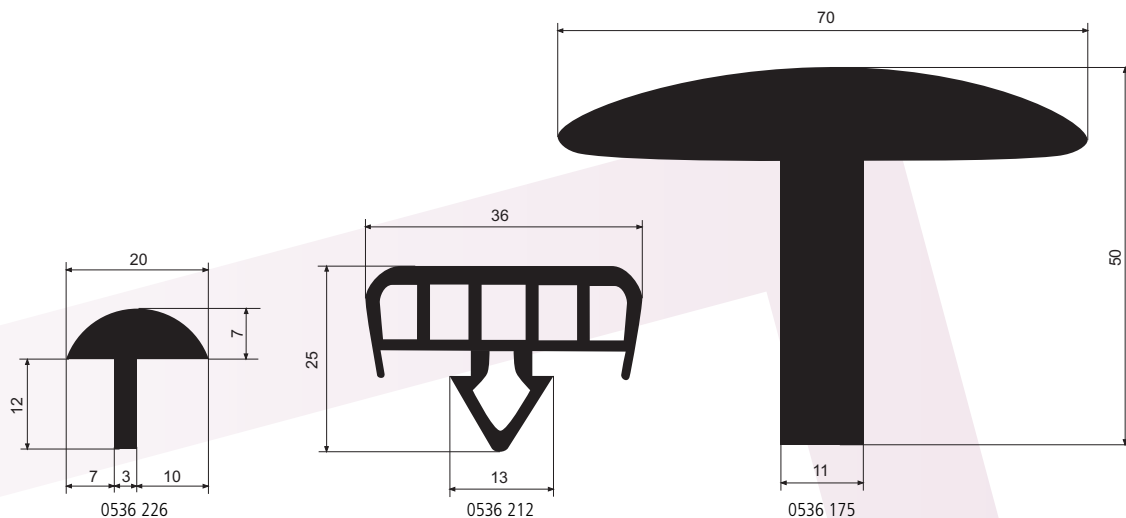

## PROFILY TVARU „OBJÍMKA“

- štandardný materiál: EPDM – odolná poveternostným vplyvom, farba čierna, niektoré profily so stopami po sivom mastenci
- sú vyrábané prevažne na objednávku
- výroba profilov na zákazku z Vami dodaných podkladov (výkresov, odtlačkov, vzoriek)

Obj. kód	Rozmer (mm)	Pre nasunutie na hrúbku materiálu (mm)	Tvrdosť (°ShA)	Balenie (m-info)	Cena (€/m)
0536 015	20	1,5	70	50	0,909
0536 089	20	5	60	50	3,802
0536 016	25	1,5	70	50	1,240
0536 101	30	4,5	60	50	4,587
0536 007	40	3,2	70	50	3,017
0536 246	40	5,2	70	50	2,727
0536 230	50	5	60	50	3,636
0536 216	50	6	70	25	5,165
0536 231	54	19	70	25	8,264

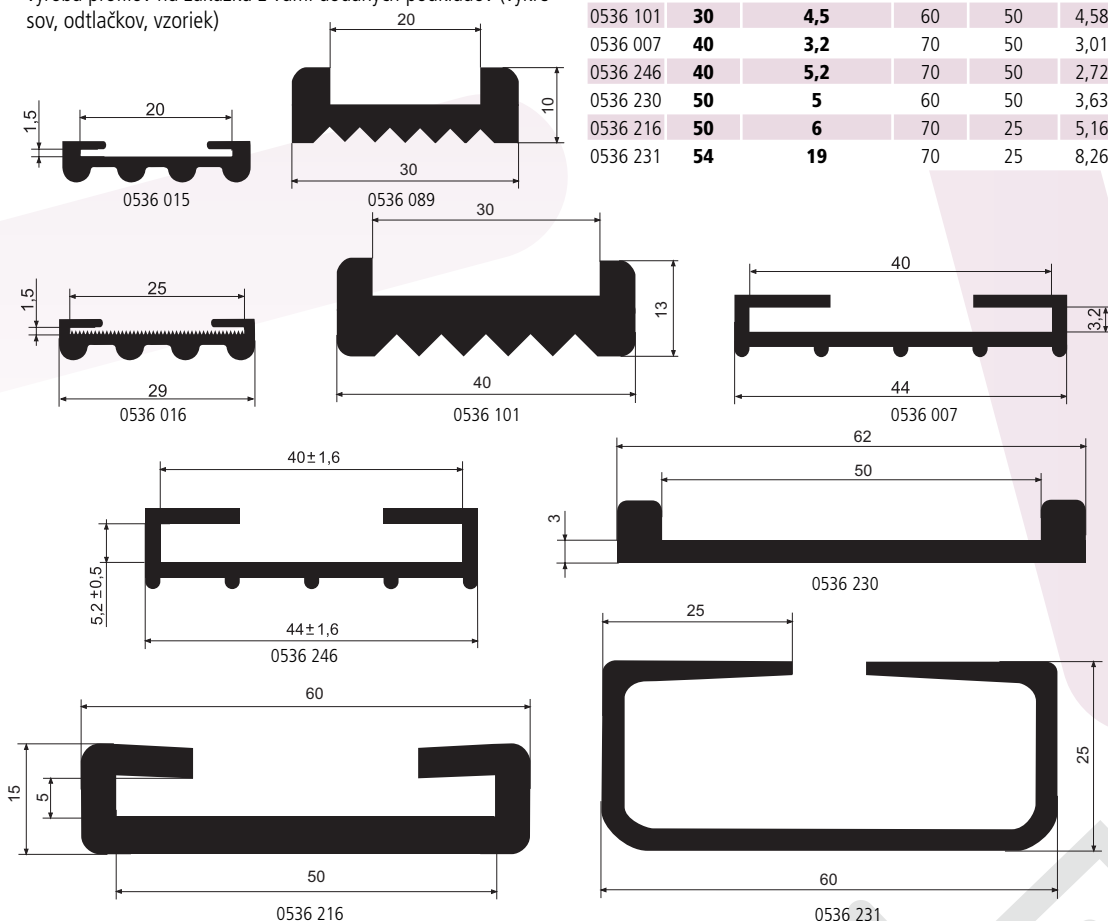



# gumové profily

## PROFILY OSTATNÉ

- štandardný materiál: **NBR, SBR, IR/NR** alebo **EPDM**, farba čierna alebo \*červená, niektoré profily so stopami po sivom mastenci
- **tvrdosť 60 °Sh**
- sú vyrábané prevažne na objednávku
- výroba profilov na zákazku z Vami dodaných podkladov (výkresov, odtlačkov, vzoriek)

Obj. kód	Rozmer (mm)	Elastomér	Tvrdosť (°ShA)	Hmotnosť (kg/m)	Balenie (m-info)	Mj.	Cena (€/Mj.)
0536 002	14×19	SBR – všeobecné	60	0,25	1	kg	14,256
0536 006	10×16×10/5,5	NBR – olejuodolné	60	0,15	1	kg	14,256
0536 008	10×21×7,5/2	SBR/NR	60	0,16	1	kg	14,256
0536 010	19×21×16	NBR – olejuodolné	60	0,45	1	kg	14,256
0536 011	23×24	NBR – olejuodolné	60	0,6	1	kg	14,256
0536 012	25×30	NBR – olejuodolné	60	0,64	1	kg	14,256
0536 017*	15×15×20	IR/NR	70	0,33	1	kg	14,256
0536 020	10×20	NBR – olejuodolné	60	0,2	1	kg	14,256
0536 023*	24×23	IR/NR	70	0,6	1	kg	14,256
0536 028	15×15×13	EPDM	70	0,205	50	m	2,893
0536 033	7×7,5/3	EPDM	40	0,06	25	m	1,446
0536 060	19×18	EPDM	70	0,4	1	kg	14,256
0536 063	10×16/5	EPDM	70	0,11	50	m	2,149
0536 083	23×27×2	EPDM	70	0,345	50	m	3,843
0536 093	25×32/5	EPDM	70	0,447	50	m	5,744

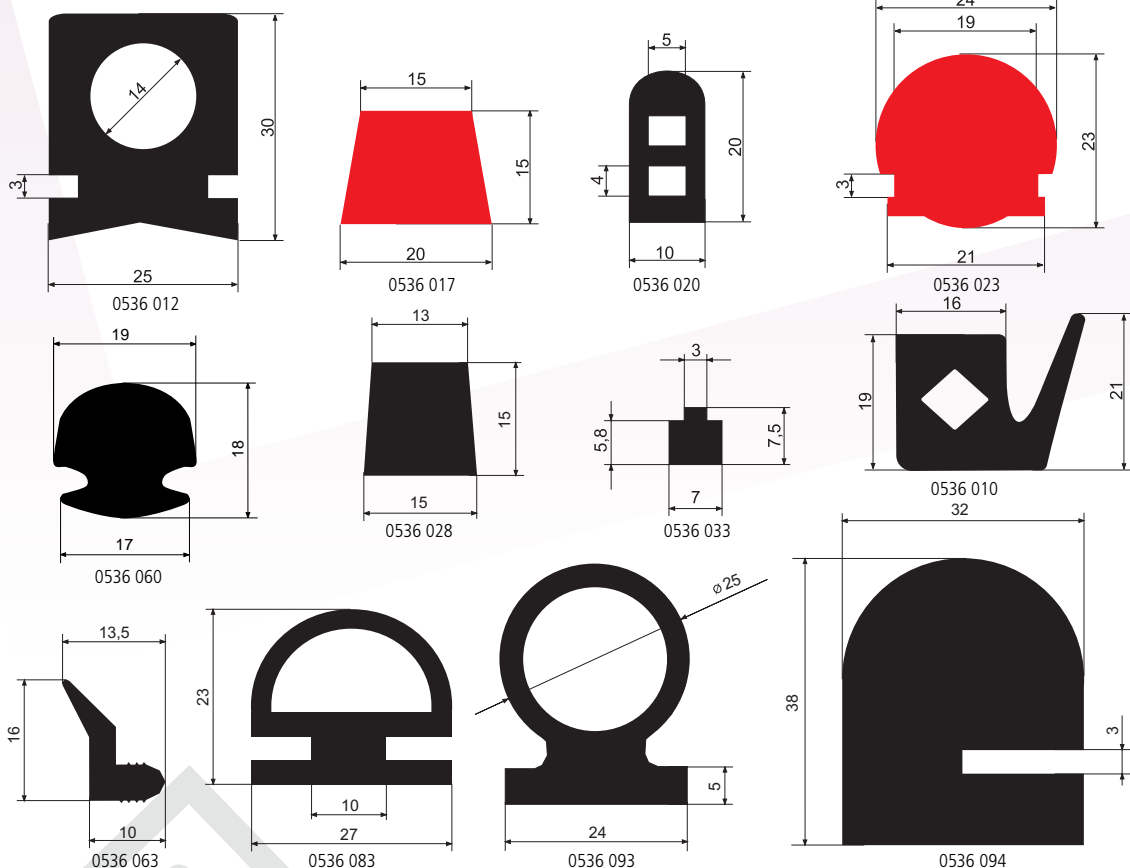
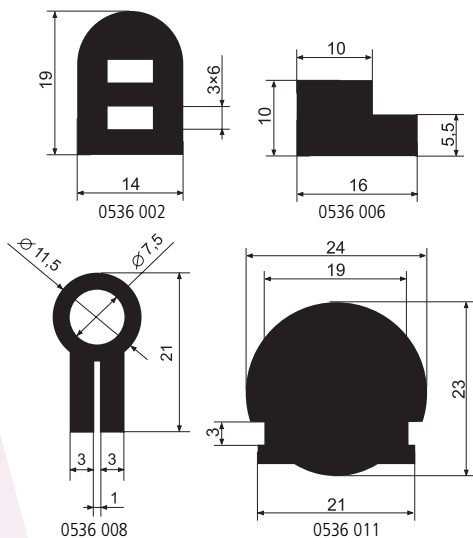

# gumové profily

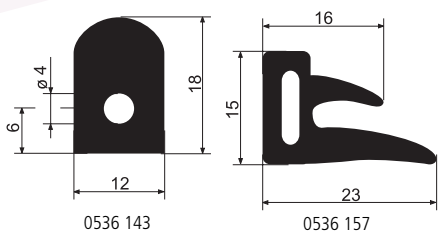
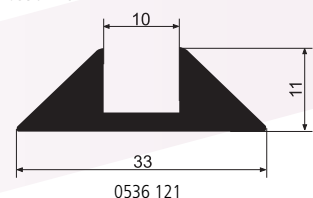
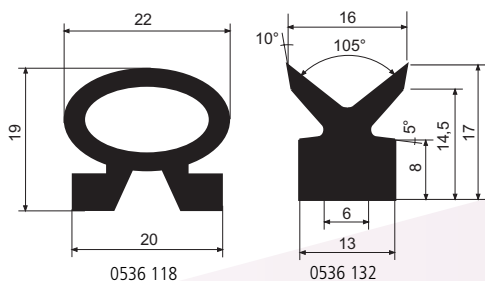

Obj. kód	Rozmer (mm)	Elastomér	Tvrdość (°ShA)	Hmotnosť (kg/m)	Balenie (m-info)	Mj.	Cena (€/Mj.)
0536 094	32x38/3	EPDM	40	1,070	40	m	15,868
0536 118	19x20/4	EPDM	60	0,259	50	m	3,388
0536 121	11x33/10	EPDM	70	0,255	50	m	2,066
0536 132	13x17/8	NBR – oleju-odolné	60	0,195	1	kg	14,256
0536 143	12x18	NBR – oleju-odolné	45	0,226	1	kg	14,256
0536 149	15x29/4	EPDM	70	0,116	100	m	1,570
0536 157	15x26x23	EPDM	60	0,185	50	m	2,893
0536 166	15,5x16,5/2	EPDM	60	0,130	100	m	1,942
0536 167	25x29/20x5500	EPDM	60	1,820	1	ks	14,339
0536 176	19,5x14/7,5	EPDM	80	0,258	25	m	3,264
0536 179	13x35/7	EPDM	70	0,200	30	m	3,926
0536 181	22x26/5	EPDM	70	0,237	50	m	5,868
0536 117	42x52x8200	EPDM	50	0,900	1	ks	58,264
0536 184	42x52x8100	EPDM	50	1,288	1	ks	44,793
0536 185	42x52x8000	EPDM	50	1,288	1	ks	44,174
0536 192	14,5x17,4/6	EPDM	70	0,151	50	m	1,240
0536 210	9x20/5	EPDM	60	0,270	100	m	2,025
0536 223	9x8/5	NBR – oleju-odolné	60	0,058	100	m	1,446
0536 227	9x5/1	EPDM	70	0,066	100	m	3,058
0536 233	9x14/2,4	EPDM	60	0,067	100	m	0,744
0536 247	3x13/1,5	NBR – oleju-odolné	60	0,032	1	kg	18,678

\*farba červená

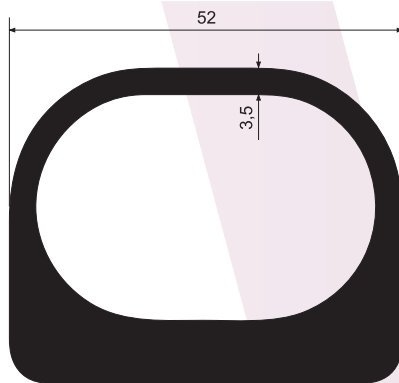
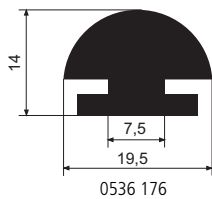
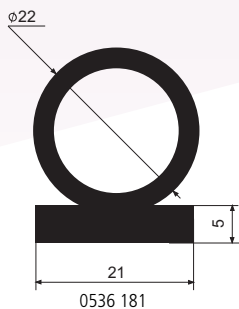
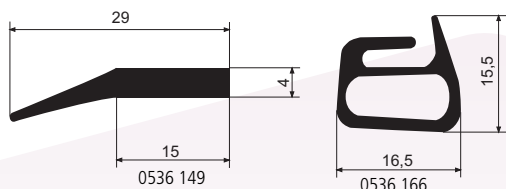

0536 117, 0536 184, 0536 185

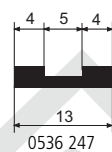
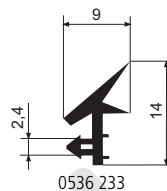
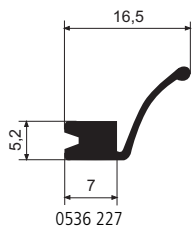
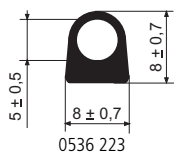
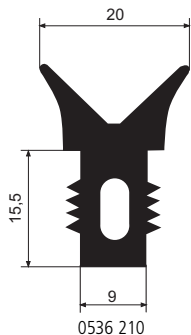
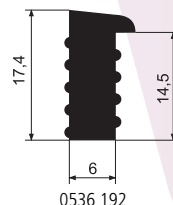
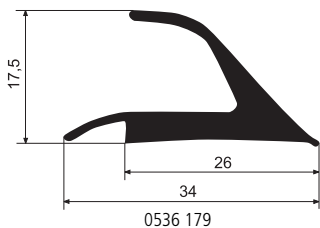



# gumové profily

PROFILY OSTATNÉ

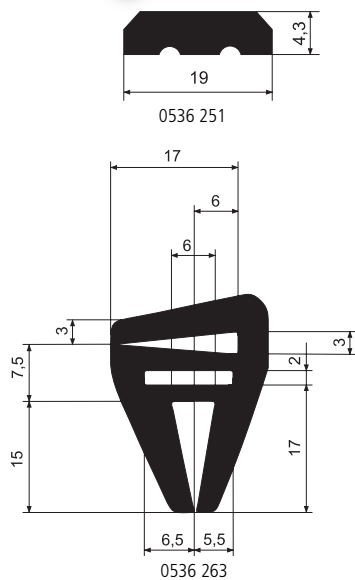

Obj. kód	Rozmer (mm)	Elastomér	Tvrdosť (°ShA)	Hmotnosť (kg/m)	Balenie (m-info)	Mj.	Cena (€/Mj.)
0536 251	<b>4,3×19</b>	NBR – olej-uodolné	60	0,106	1	kg	16,860
0536 263	<b>21×29/3</b>	EPDM	70	0,39	1	kg	14,256
0536 267	<b>16×15×12</b>	EPDM	70	0,241	1	kg	14,256
0536 271	<b>11×33/8</b>	EPDM	70	0,28	50	m	2,893
0536 317	<b>22,6×26,8/2,6</b>	EPDM	70	0,25	50	m	2,066
0536 200	<b>14×52/10</b>	EPDM	60	0,55	25	m	7,810
0536 201	<b>20×39/4</b>	EPDM	70	0,60	25	m	7,273
0536 232	<b>14×28/2,5</b>	EPDM	60	0,82	25	m	10,579
0536 360	<b>14,4×23,7/7</b>	SBR – všeobecné	60	0,25	1	m	3,430

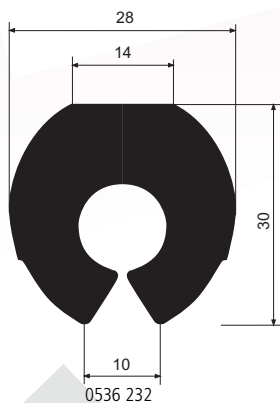
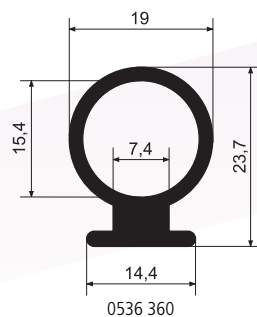
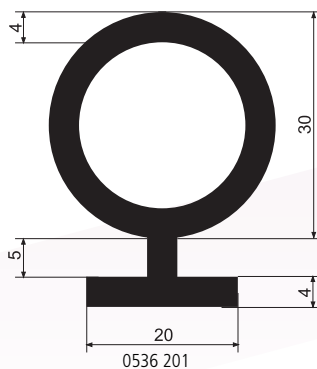
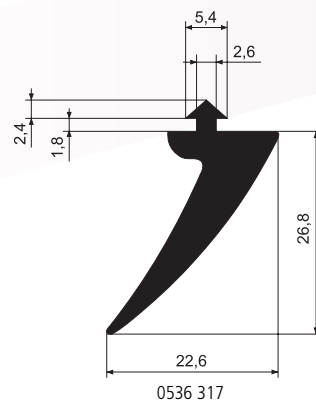
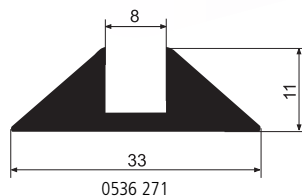
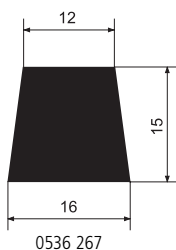

👁️ Dodávame aj profily so sametkou – 1528 xxx.

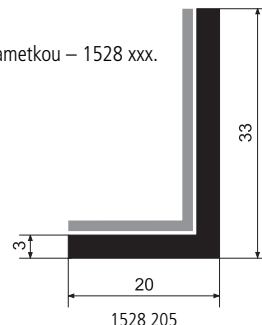
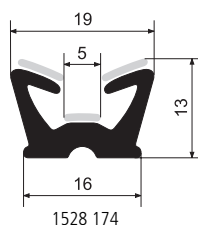

👁️ Dalších cca 1500 typů profilů v nabídce.

## PROFILY ZO SILIKÓNOVEJ GUMY

- na objednávku dodávame rôzne typy profilov zo silikónovej kompaktnej gumy

Profilujú majú **obvykle tieto parametre:**

- štandardná farba: transparentná, elastomé: silikón VMQ
- tvrdosť: **60 °Sh**, hustota: 1190 kg/m<sup>3</sup>
- pracovná teplota: **-60 °C/+200 °C**
- termín dodania: 4 týždne
- **minimum: 25 m**, cena profilu závisí na objednanom množstve
- za vývoj nového profilu účtujeme cca 150–300,- € (hubica zostáva majetkom dodávateľa)
- pri výbere z už existujúcich profilov sa žiadny vývoj nehradí

Navštívte našu adresu pre silikónové profily na mieru:

<http://www.gumex.sk/html/profiluj-na-miru.html>

- vyberte si jeden zo 136 základných tvarov silikónových profilov, dosadte hodnoty k jednotlivým kótam podľa ponuky tabuľky, uďte množstvo a odošlite dopyt a my Vám ponúkame profil, na ktorý už **existuje vytlačací nástroj, alebo Vám vytvoríme profil presne podľa Vašich rozmerov vid. červený odkaz „Vlastné rozmery profilov“**.

**Pre zákazkovú výrobu profilov iných tvarov, než aké uvádzame na našom webe, potrebujeme mať: technický výkres výrobku alebo jeho vzorku, poznať tvrdosť, farbu, prípadne ďalšie špecifikácie.**

- objednávaci kód silikónových profilov vyrábaných na objednávku – 0504 xxx.

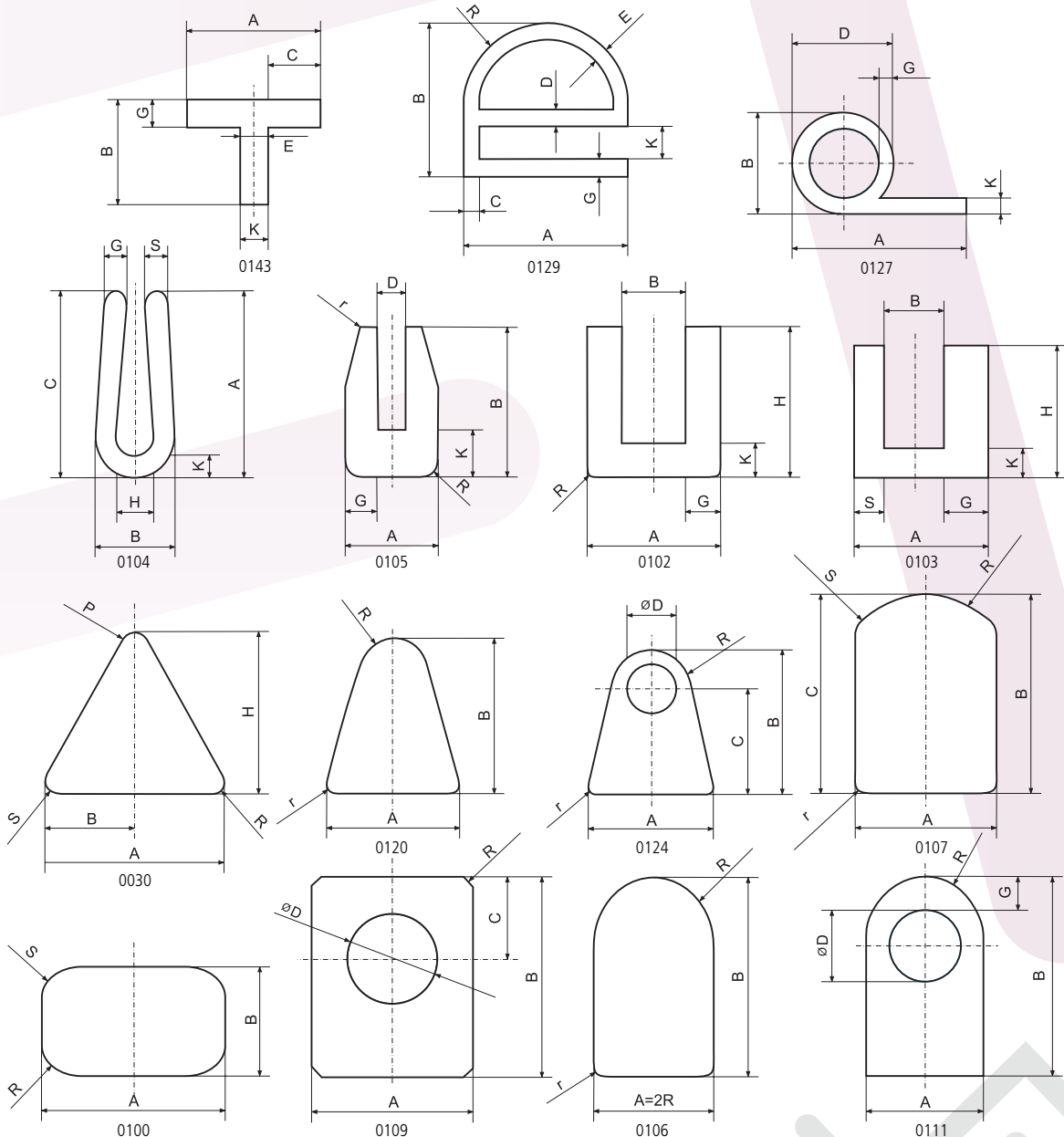

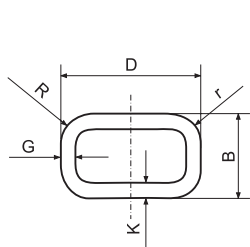

0153

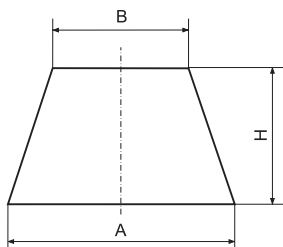

0023

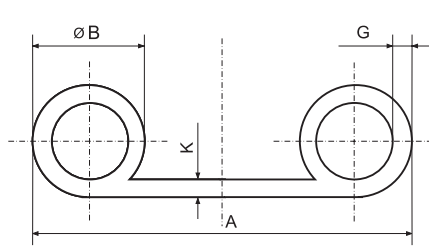

0128

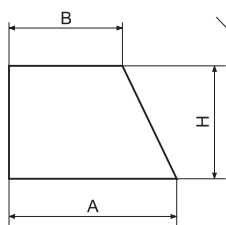

0024

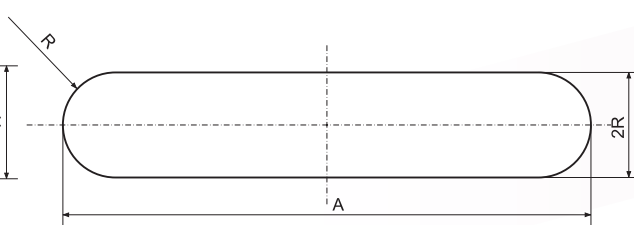

0101

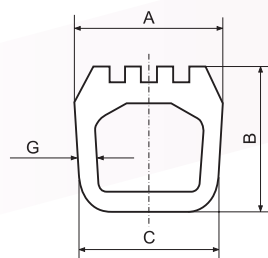

0183

## PROFILY PIRELI – PROFILY S KOVOVOU VÝSTUHOU

### „U“ PROFIL PIRELI

- štandardné parametre: čierna farba, EPDM, alebo PVC
- dobrá odolnosť voči poveternostným vplyvom a ozónu, oderu, chemikáliám
- štandardné vyhotovenie: s ocelovou výstuhou
- pracovná teplota pre EPDM:  $-40\text{ }^{\circ}\text{C}/+100\text{ }^{\circ}\text{C}$
- pracovná teplota pre PVC:  $-20\text{ }^{\circ}\text{C}/+60\text{ }^{\circ}\text{C}$

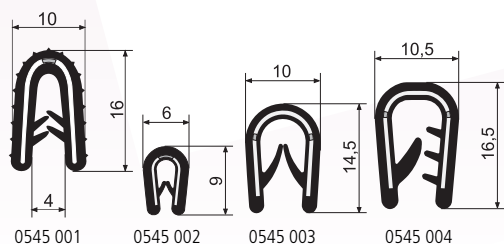

0545 001

0545 002

0545 003

0545 004

Obj. kód	Typ	Materiál	Pre nasunutie na materiál hrúbky (mm)	Farba	Balenie (m-info)	Cena (€/m)
0545 001	<b>273449121001</b>	EPDM	2–3	čierna	25	1,198
0545 002	<b>A1010</b>	PVC	1–2	čierna	100	1,074
0545 003	<b>A1015</b>	PVC	1–4	čierna	100	1,322
0545 004	<b>A1024/4</b>	PVC	2–4	čierna	100	1,446
0545 005	<b>A1011</b>	PVC	1–2	biela	100	1,529
0545 006	<b>A2051</b>	PVC	1–3	čierna	100	1,777
0545 007	<b>A1012</b>	PVC	1–2	sivá	100	1,116
0545 008	<b>A2613</b>	EPDM	1–4	čierna	100 (min. 4000)	3,099
0545 009	<b>A1019/8</b>	PVC	6–8	čierna	100	1,736
0545 010	<b>A1013</b>	PVC	1–2	čierna	100	1,157
0545 011	<b>A1014</b>	PVC	1–2	biela	100	3,926
0545 013	<b>A1009</b>	PVC	0,8–1,5	čierna	25	1,033

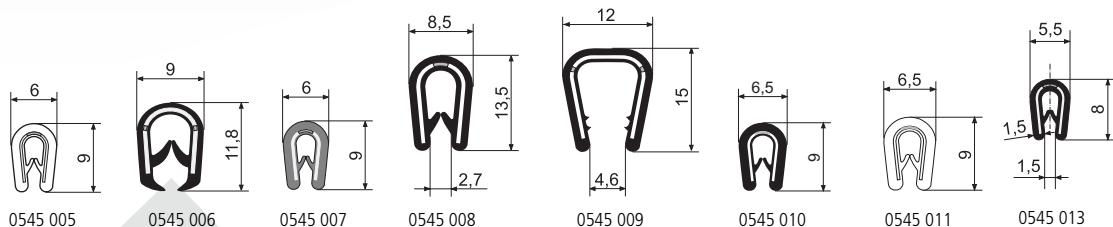

0545 005

0545 006

0545 007

0545 008

0545 009

0545 010

0545 011

0545 013

➤ Ďalšie profily na objednávku v ponuke.

## „U“ PROFIL PIRELI S BOČNÝM TESNENÍM

- štandardné parametre: čierna farba, EPDM
- dobrá odolnosť voči poveternostným vplyvom a ozónu, oderu, chemikáliám
- štandardné vyhotovenie: s oceľovou výstuhou
- pracovná teplota: -40 °C/+100 °C

Obj. kód	Typ	Materiál	Pre nasunutie na materiál hrúbky (mm)	Balenie (m-info)	Cena (€/m)
0546 001	<b>2734492210017033</b>	EPDM	2-3	20	1,529
0546 002	<b>A1101</b>	U-PVC, brucho EPDM	1-2	100	2,231
0546 003	<b>A1100</b>	U-PVC, brucho EPDM	1-4	50	3,636
0546 004	<b>A1503</b>	EPDM	1-3,5	25	2,975
0546 005	<b>A1549</b>	EPDM	2	50	1,942
0546 006	<b>A2540</b>	EPDM	2-4	25	2,231
0546 007	<b>A3224/6</b>	EPDM	5-6	75	3,223
0546 008	<b>A2106/4</b>	U-PVC, brucho EPDM	2,5-4	50	5,496
0546 009	<b>A1103</b>	U-PVC, brucho EPDM	1-4	50	3,140
0546 010	<b>A3074</b>	EPDM	1-2	50	2,562
0546 011	<b>A2554</b>	EPDM	1,5-3	25	3,967
0546 012	<b>A2539</b>	EPDM	1,5-3	25/100	2,645
0546 013	<b>A2533</b>	EPDM	2-2,5	100	2,025
0546 014	<b>A2126</b>	EPDM	2-4	25	9,463
0546 015	<b>A2506 S</b>	EPDM	2	50/100	2,190
0546 016	<b>A1526</b>	U-PVC, brucho EPDM	1-3,5	100	4,545
0546 017	<b>A1114</b>	U-PVC, brucho EPDM	1-4	50	2,934
0546 018	<b>A2541</b>	U-PVC, brucho EPDM	4-6	25	4,917

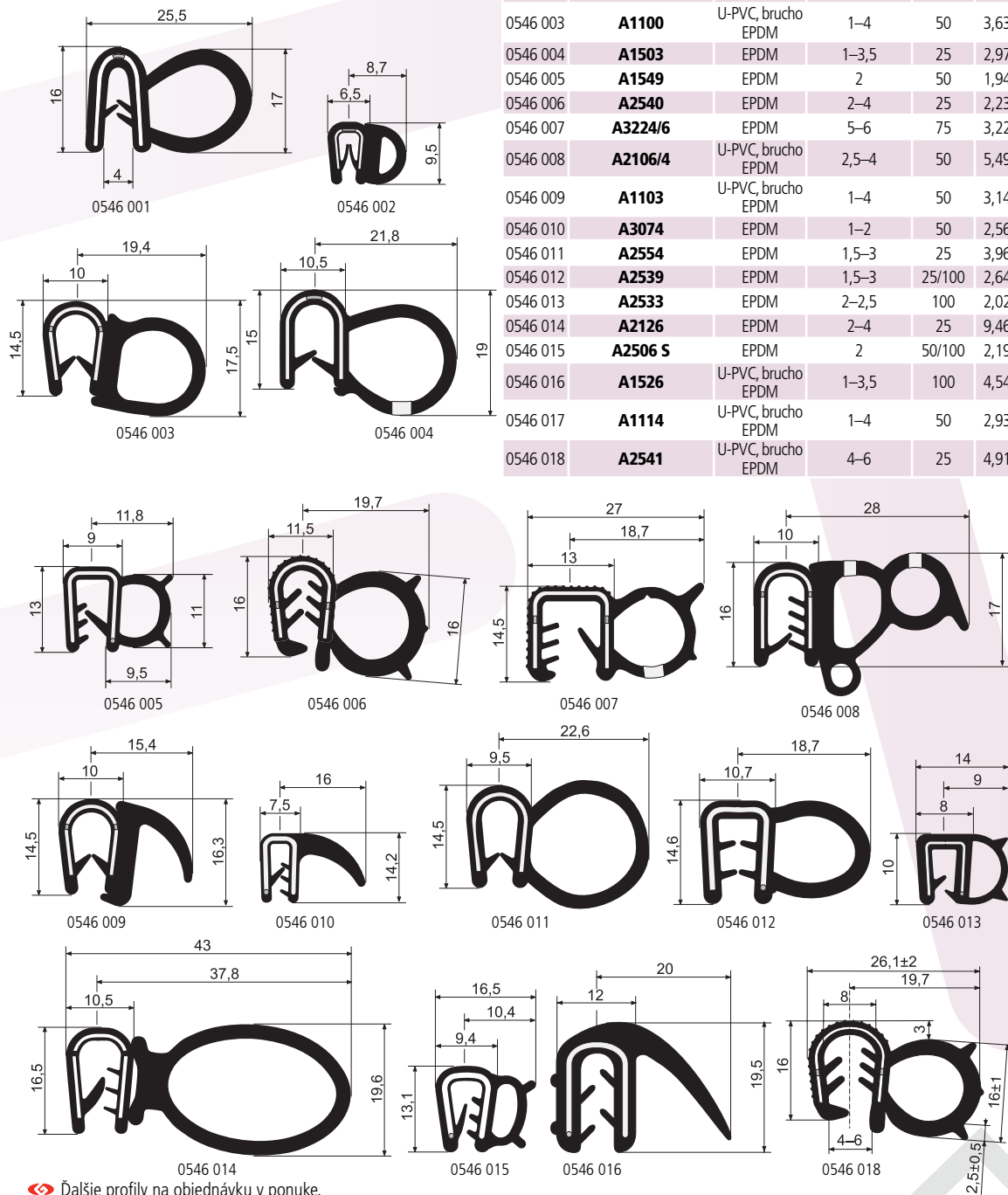

- Ďalšie profily na objednávku v ponuke.
- Profily z iných materiálov a kombinácií materiálov v ponuke.



## „U“ PROFIL PIRELI S HORNÝM TESNENÍM

- štandardné parametre: čierna farba, EPDM
- dobrá odolnosť voči poveternostným vplyvom a ozónu, ode-ru, chemikáliám
- štandardné vyhotovenie: s oceľovou výstuhou
- pracovná teplota: -40 °C/+100 °C

Obj. kód	Typ	Materiál	Pre nasunutie na materiál hrúbky (mm)	Balenie (m-info)	Cena (€/m)
0547 001	A1102	U-PVC, brucho EPDM	1-4	50	2,893
0547 002	A1104/2	U-PVC, brucho EPDM	1-2,5	50	3,512
0547 003	A1110	U-PVC, brucho EPDM	1-4	50	4,545
0547 004	A2513	EPDM	1-3	50	1,942
0547 005	A2516/2	EPDM	1-2,5	50	2,562
0547 016	A2516/4	EPDM	2-4	50	2,603
0547 006	A1117	U-PVC, brucho EPDM	1-4	50	4,256
0547 007	A2207	U-PVC, brucho EPDM	4-6	50 (min. 1000)	2,934
0547 008	A1500	EPDM	2-4	50	3,223
0547 009	A1119	EPDM	1-4	50	5,372
0547 010	A1077	U-PVC, brucho EPDM	0,5-3	100	2,231
0547 011	A3525-MA	U-PVC, brucho EPDM	1-4	100 (min. 1000)	5,702
0547 012	A1501	EPDM	1,5-2,5	50	2,893
0547 013	A1105/6	EPDM	4-6	25	6,570
0547 014	A1105/4	EPDM	2-4	25	6,570
0547 015	A2518	EPDM	1-2	50 (min. 1000)	1,694

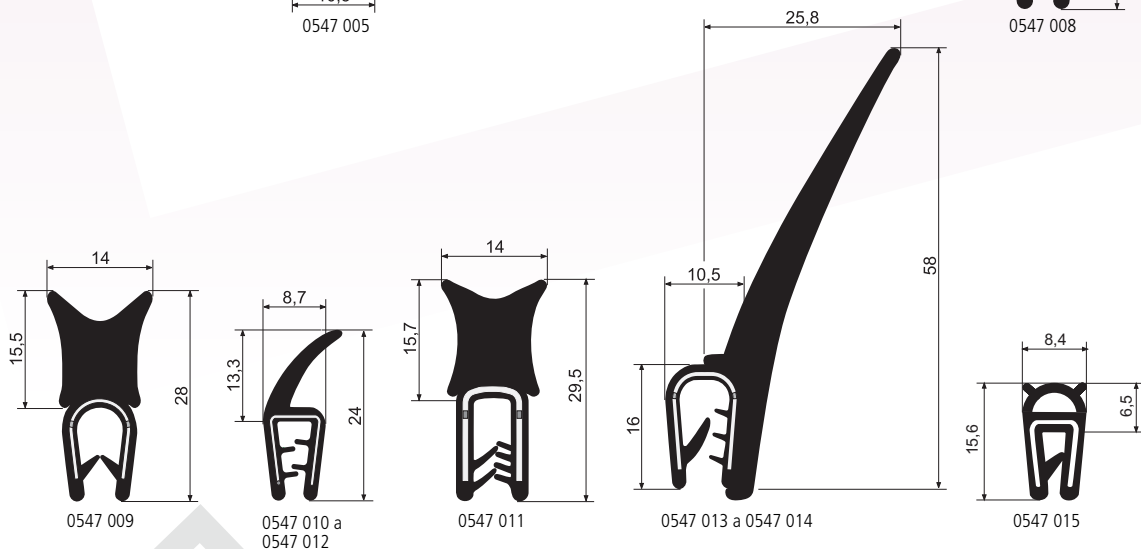
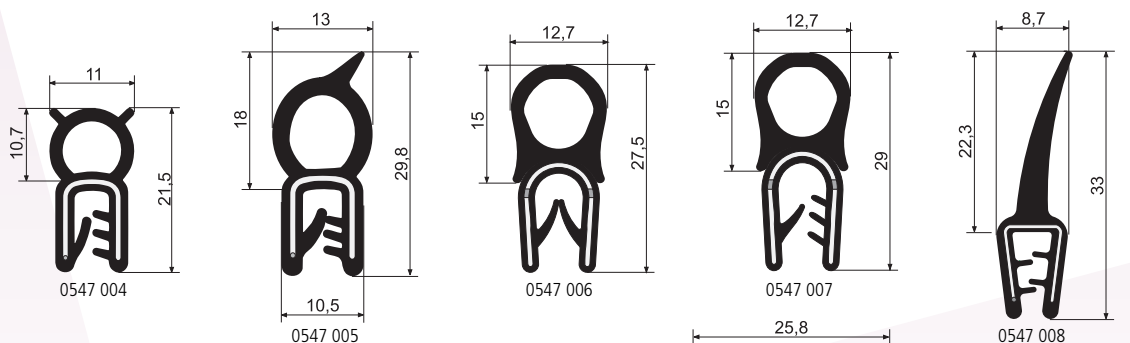
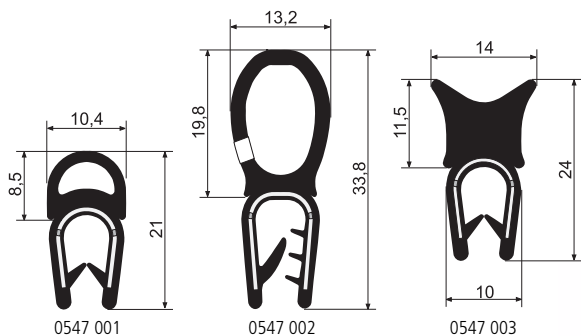

- Další profily na objednávku v ponuke.
- Profily z iných materiálov a kombinácií materiálov v ponuke.

## TESNENIE OKIEN DOPRAVNÝCH PROSTRIEDKOV

### TESNENIE BOČNÝCH A ČELNÝCH SKIEL

- elastomér: EPDM (odolný poveternostným vplyvom), čierna farba
- ďalšie typy na objednávku

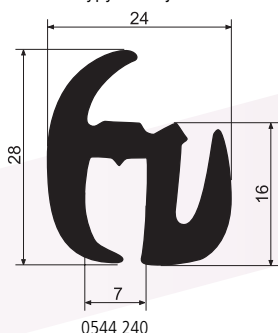

0544 240

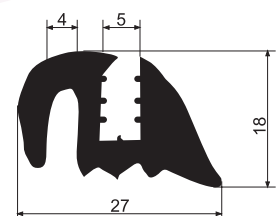

0544 260

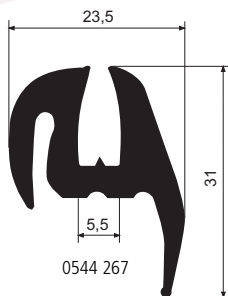

0544 267

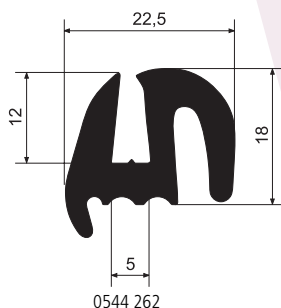

0544 262

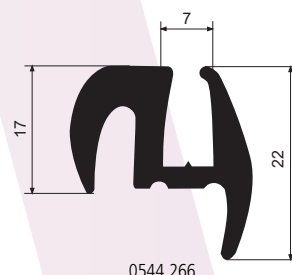

0544 266

Obj. kód	Rozmer (mm)	Tvrdosť (°ShA)	Balenie (m-info)	Cena (€/m)
0544 240	24×28/7	70	25	3,554
0544 260	18×27/4	60	50	4,628
0544 262	18×22,5/5	70	25	4,587
0544 266	17×22/7	70	50	6,322
0544 267	23×30/5,5	60	50	5,661

### TESNENIE OKIEN AUTOMOBILOV

- elastomér: EPDM (odolný poveternostným vplyvom) čierna farba, alebo SBR/IR, čierna farba so stopami po šedom masťenci
  - niektoré profily len na objednávku
  - ďalších cca 30 typov na objednávku
- V stĺpci „klin do profilu“ je uvedený objednávací kód príslušného klinu.

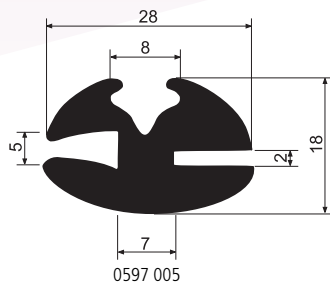

0597 005

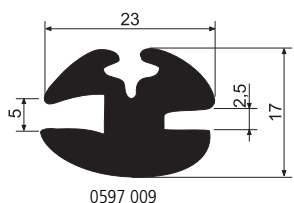

0597 009

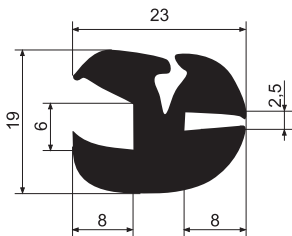

0597 001

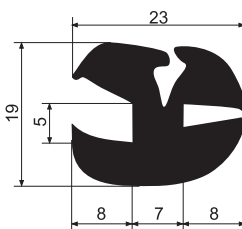

0597 003

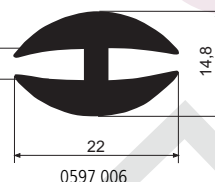

0597 006

Obj. kód	Typ	Elastomér	Klin do profilu	Tvrdosť (°ShA)	Hmotnosť (kg/m)	Balenie (m-info)	Mj.	Cena (€/Mj.)
0597 005	1447	SBR/IR	0598 003	70	0,510	-	kg	4,669
0597 009	1918	SBR/IR	0598 003	70	0,355	-	kg	4,421
0597 001	B1120	EPDM	0598 001	70	0,350	20	m	4,711
0597 003	B1127	EPDM	0598 001	70	0,345	20	m	6,033
0597 006	217090195	EPDM	bez klinku	70	0,240	100	m	2,975
0597 007	216090128	EPDM	bez klinku	62	0,150	50	m	2,355
0597 008	217090203	EPDM	bez klinku	70	0,411	50	m	5,331
0597 010	B1123	EPDM	0598 001	70	0,320	20	m	5,661
0597 012	B1112	EPDM	0598 002	70	0,145	20	m	2,231
0597 013	217090250	EPDM	0598 004	70	0,182	50	m	3,678
0597 014	B1115	EPDM	0598 002	70	0,165	25	m	2,603
0597 015	217090270	EPDM	0598 005	70	0,593	50	m	10,702
0597 016	B1117	EPDM	0598 001	70	0,430	15	m	6,198
0597 017	D1013	EPDM	bez klinku	70	0,221	50	m	4,050
0597 018	D1123	EPDM	bez klinku	70	0,360	25	m	3,760
0597 019	B1113	EPDM	0598 001	70	0,410	15	m	5,496
0597 020	217090406	EPDM	bez klinku	70	0,250	50	m	2,851

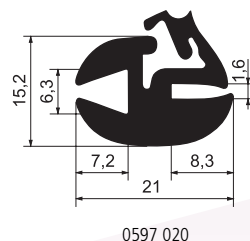
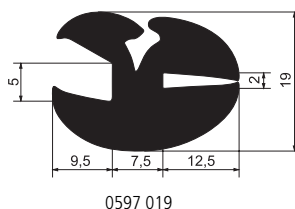
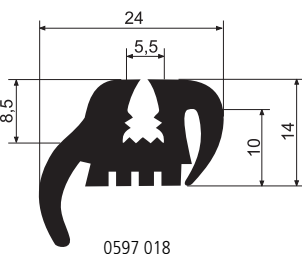
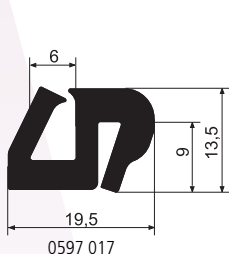
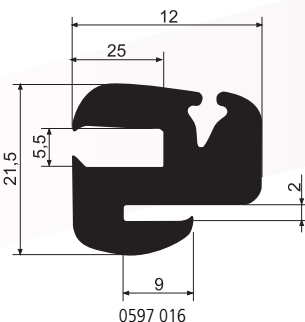
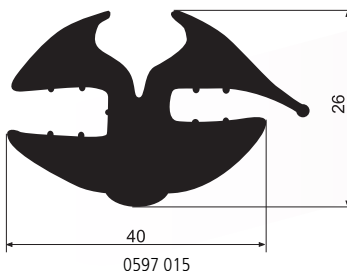
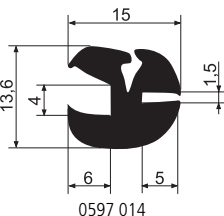
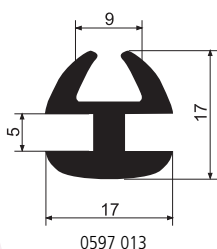
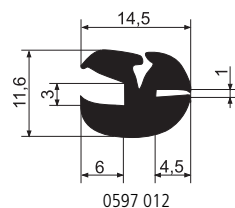
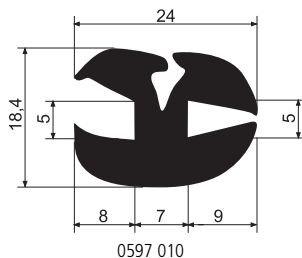
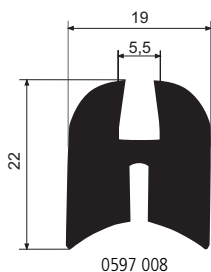
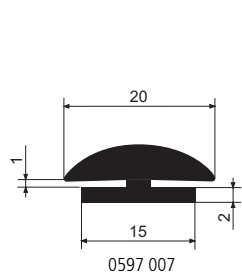

## KLINY K TESNENIU OKIEN AUTOMOBILOV

- elastomér: EPDM (odolný poveternostným vplyvom), čierna farba
- niektoré profily len na objednávku
- ďalšie rozmery klinov na objednávku

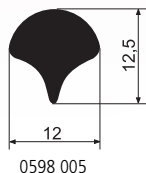

0598 005

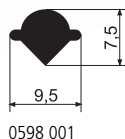

0598 001

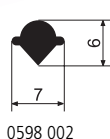

0598 002



0598 003

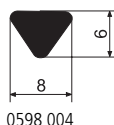

0598 004

Obj. kód	Typ	Tvrdosť (°ShA)	Hmotnosť (kg)	Balenie (m-info)	Cena (€/m)
0598 005	<b>217090271</b>	70	0,118	50	3,678
0598 001	<b>C1202</b>	80	0,050	50	0,826
0598 002	<b>C1201</b>	80	0,028	50	1,240
0598 003	<b>1765</b>	70	0,040	200	0,372
0598 004	<b>217090249</b>	70	0,060	200	2,645

Na objednávku dodávame gumové priechodky – 1410 xxx.



1410 xxx